

MHHS - Migration Design Document

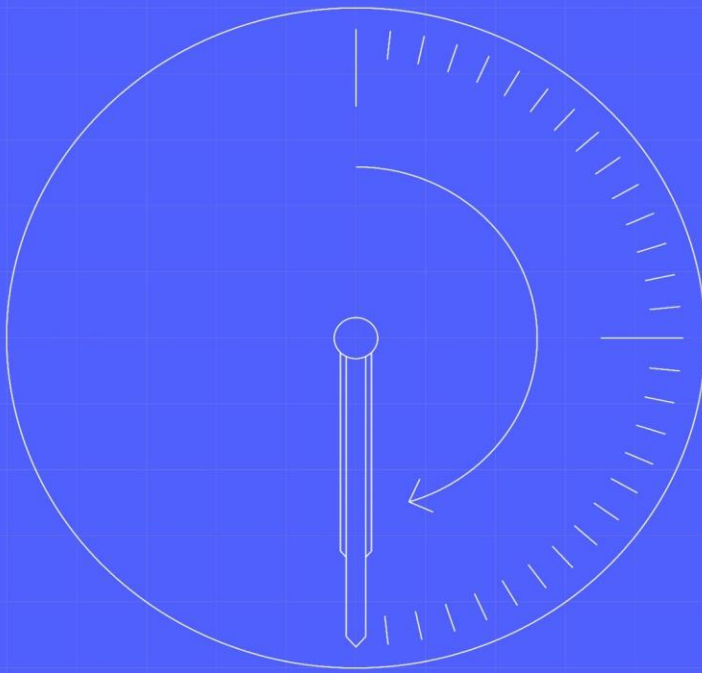

Document Owner:
Migration Design Team

Document Number:
DEL961

Version:
1.43

Status:
**Baselined following DAG
Approval**

Date:
030/054/20243

Classification:
Public

1 Contents

1 Contents	1
1.1 Change Record	3
1.2 References	3
1.3 Terminology	43
1.4 Core Design	4
1.5 Programme Milestones	4
2 Introduction, Overview and Scope	5
2.1 Introduction	5
2.2 Overview	5
2.3 Scope	5
3 Intended Audience	6
3.1 Intended Audience	6
4 Assumptions, Risks and Dependencies	6
4.1 Assumptions	6
4.2 Risks	7
4.3 Dependencies	7
5 Design Detail – Registration Service	8
5.1 Management of Forward and Reverse Migration Process	8
5.2 Migration and Customer Switching	8
5.3 Migration Lifecycle	9
6 Design Detail – Forward Migration - CoA	11
6.1 Traditional Metering	11
6.2 Advanced Metering (NHH)	1514
6.3 Advanced Metering (HH)	1716
6.4 Smart Metering (NHH)	18
6.5 Smart Metering (HH)	20
6.6 Unmetered MPANs	2221
7 Design Detail – Forward Migration - CoS	2523
7.1 Traditional Metering	2523
7.2 Advanced Metering (HH)	2826
7.3 Advanced Metering (NHH)	3028
7.4 Smart Metering (NHH)	3229
7.5 Smart Metering (Elective HH)	3432
7.6 Unmetered MPANs	3533
8 Reverse Migration – CoS	3734
8.1 Traditional Metering	3735
8.2 Advanced Metering	4139
8.3 Smart Metering	4542
8.4 Unmetered Sites	4846
9 Related MPANs	5047

10 Import / Export MPANs	<u>5047</u>
11 Exception Handling	<u>5048</u>
12 Non- Functional Requirements / Constraints	<u>5249</u>
13 Required Interface Changes to Support Migration Design	<u>5249</u>
13.1 Legacy Data Flow Changes	<u>5250</u>
13.2 MHHS Interface Specification Changes	<u>5653</u>
13.3 Industry Standing Data (ISD) Entity Design	<u>6158</u>
14 Reporting	<u>6258</u>
15 Additional Artefacts / Appendix	<u>6359</u>

1.1 Change Record

Date	Author	Version	Change Detail
13/02/2023	Migration Design Team	0.1	Document published for consultation
15/03/2023	Migration Design Team	0.2	Document updated with consultation feedback ahead of Assurance
24/03/2023	Migration Design Team	0.3	Document updated post-Assurance
03/04/2023	Migration Design Team	1.0	Baselined following DAG approval
27/10/2023	Migration Design Team	1.1	DIN-425
18/01/2024	Design Team	1.2	DIN-837
15/03/2024	Design Team	1.3	DIN 762, 946, 949
03/06/2024	Design Team	1.4	DIN-984/985/1021/1022

Formatted: Font color: Red

1.2 References

Document	Publisher	Published	Additional Information
MHHS-DEL962 – BPM-001 – Change of Supply – Forward Migration v1.0	Migration Design Team	03/04/2023	
MHHS-DEL963 – BPM-002 – Change of Service – Metering Service – Forward Migration v1.0	Migration Design Team	03/04/2023	
MHHS-DEL964 – BPM-003 – Change of Service – Data Service – Forward Migration v1.0	Migration Design Team	03/04/2023	
MHHS-DEL965 – BPM-001 – Change of Supply – Reverse Migration v1.0	Migration Design Team	03/04/2023	
MHHS-DEL966 – BPM-002 – Change of Service – Metering Service – Reverse Migration v1.0	Migration Design Team	03/04/2023	
MHHS-DEL967 – BPM-003 – Change of Service – Data Service – Reverse Migration v1.0	Migration Design Team	03/04/2023	
MHHS-DEL968 – BPD001 – Change of Supply (Forward Migration) v1.0	Migration Design Team	03/04/2023	
MHHS-DEL969 – BPD002 – Change of Service – Metering Service (Forward Migration) v1.0	Migration Design Team	03/04/2023	
MHHS-DEL970 – BPD003 – Change of Service – Data Service (Forward Migration) v1.0	Migration Design Team	03/04/2023	
MHHS-DEL971 – BPD001 – Change of Supply – Reverse Migration v1.0	Migration Design Team	03/04/2023	
MHHS-DEL972 – BPD002 – Change of Metering Service – Reverse Migration v1.0	Migration Design Team	03/04/2023	
MHHS-DEL973 – BPD003 – Change of Data Service – Reverse Migration v1.0	Migration Design Team	03/04/2023	
MHHS-DEL974 – Migration Design Requirements Log v1.0	Migration Design Team	03/04/2023	
MHHS-DEL989 - IF-003 Interface Specification v1.0	Migration Design Team	03/04/2023	

1.3 Terminology

Term	Description
BAU Process	This refers to a process within the MHHS arrangements as set out within the MHHS Core Design
CoA	Change of Agent
CoS	Change of Supplier
CSS	Central Switching Service
Data Cleanse Plan	The approach and activities required to improve and populate data prior to Migration start
DC	Data Collector
DS	Data Service
Forward Migration	The process through which MPANs will move from Legacy arrangements to MHHS arrangements.
ISD	Industry Standing Data
LDSO	Licensed Distribution System Operator
Legacy Arrangements	The existing arrangements set out under the BSC and REC. For the purposes of the Migration Design, this is primarily the REC Metering Services Schedule and the Balancing and Settlement Procedures related to Data Collection.
MHHS	Market-Wide Half-Hourly Settlement
MHHS Arrangements	The new MHHS arrangements as set out in the MHHS Core Design Artefacts.
Migration Design	The technical articulation of how MPANs will move from Legacy to new MHHS arrangements.
Migration Period	The period denoted by the Programme as occurring between the M11 and M15 milestones.
MOP	Meter Operator
MPAN	Metering Point Administration Number
MS	Metering Service
Primary MPAN	The MPAN, within a Related MPAN arrangement, for which a Switch is initiated or a Forward Migration (via an IF-031) is initiated.
Qualified Supplier	A Supplier recognised in ISD as both having passed the relevant System Integration Testing (SIT) requirements or BSC qualification requirements; and declared that their service is operational within the MHHS arrangements.
Registration Service	The service operated by LDSOs
Reverse Migration	The process through which MPANs will move from MHHS arrangements to Legacy arrangements.
Secondary MPAN	The MPAN, within a Related MPAN arrangement, for which a Forward Migration occurs when an IF-031 is received for a Primary MPAN.
Switch	The process by which a new Supplier Registration supersedes an existing Supplier Registration, managed by the CSS.

1.4 Core Design

The Migration Design set out in this document is aligned to the Baselined v5.0 version of the MHHS Core Design.

1.5 Programme Milestones

The below programme milestones are referenced throughout the Migration Design.

M11 – Start of 1 Year Migration for UMS / Advanced

M12 – Start of 1 Year Migration for Smart / Non-smart

M14 – All Suppliers must be able to access MPANs under the new TOM

M15 – Full transition complete

2 Introduction, Overview and Scope

2.1 Introduction

The objective of the Migration Design document is to articulate the technical process through which MPANs will be migrated from Legacy arrangements to the new MHHS arrangements, and in the case of Reverse Migration, back to the Legacy arrangements from MHHS arrangements.

Its purpose is not to provide detail on the Legacy or MHHS BAU processes, although these processes will be referenced throughout the document.

This document aims to provide a 'plain English' verbal explanation of the Migration processes set out by the remaining suite of Migration Design Artefacts. Together these two sets of documents articulate the Migration Design in full and they are designed to be read alongside one another.

2.2 Overview

The following sections are included within this document:

- An explanation of who this document has been written for, including a description of all impacted Parties;
- A summary of the assumptions, risks and dependencies that are relevant to the Migration Design;
- A detailed step-by-step explanation of the Design, including the impacts and non-functional requirements;
- And the proposed reporting process for the Migration period.

The Migration Design is based on the MHHS BAU processes used for the Change of Supply (MHHS BPM001), Change of Service - Metering Service (MHHS BPM002) and Change of Service - Data Service (MHHS BPM003). One of the key Design principles we have adhered to, is to introduce as little avoidable change to these processes as possible, whilst simultaneously acknowledging that some degree of change is inevitable in the development of the Migration processes.

2.3 Scope

The scope for this document includes:

- A summary of the intended audience for this document.
- A summary of relevant assumptions, risks, and dependencies.
- A written description of the CoA (MS), CoA (DS) and CoS Forward Migration processes and the Reverse Migration process.
- The operational choreography for the above processes.

This document does not cover the following areas:

- Business Process Map (BPM) diagrams – these are contained within the accompanying suite of Artefacts instead.
- A list of all functional requirements – these are contained within the accompanying suite of Artefacts instead.

- A list of all recommendation points which the MDSG has achieved consensus on – this is contained within the accompanying suite of Artefacts instead.
- An articulation of the MHHS BAU processes – this is a responsibility of the Core Design team.
- Transition Approach: The end-to-end approach to reflect how new services are introduced, redundant services are closed, and enduring services are updated to support MHHS Design
- Migration Execution: The implementation of Migration activities and processes to move the servicing of MPANs from Legacy to new MHHS arrangements.

3 Intended Audience

3.1 Intended Audience

This document has been addressed to an audience with a strong level of technical and Design understanding, given the material discussed however, the document is open and accessible to all participants in the MHHS Programme that would like to understand more about the MHHS Migration processes.

Particular focus has been given in this document to the parties that are impacted by this Design and will have to make process changes to support the Migration Design.

These parties are:

- The Registration Services,
- DNOs,
- Suppliers,
- Data Collectors / Aggregators,
- Meter Operators,
- The DIP owner,
- Metering Services,
- Data Services,
- EES,
- LDSOs.
- Meter Administrators

Further parties may be impacted by this Design however, the Migration Design team has not identified specific requirements of any other parties.

4 Assumptions, Risks and Dependencies

4.1 Assumptions

- There will be Advanced meters operating under both NHH and HH arrangements when Migration starts.
- All Unmetered Sites will be operating under HH arrangements when Migration starts.
- If a Supplier is MHHS Qualified, they will not be able to 'choose' to reverse migrate an MPAN. An MPAN will only ever undergo Reverse Migration when it is being settled via the new MHHS arrangements and is Switched from a MHHS Qualified Supplier to a Supplier who is not MHHS Qualified. For this reason, a Reverse Migration cannot occur via a CoA Migration.
- There are no other Migration processes apart from those set out within this document. However, there will exist certain MPANs which will require enhanced activities to occur to support Migration,

e.g., Complex Sites. The functional Design set out in this document will support those 'edge cases'; although supporting policies for the treatment of those sites, for Migration, will be agreed and documented within the Migration Working Group.

- No customer segments are to be excluded for the purposes of Reverse Migration because of the technical Design. However, several complexities have been identified within the Migration Design Subgroup, which may result in a decision being made to exclude certain Market Segments or metering configurations or place conditions on what arrangements certain meter types should be operated under following Reverse Migration. As the technical Design is agnostic of those considerations' exclusions will be discussed further under the Migration Working Group.
- For the purposes of BPM-001- Change of Supply – Forward Migration, the MPAN is operating under Legacy processes and the incoming Supplier is Qualified.
- The definition as to what constitutes a Qualified Supplier is defined within Industry Standing Data (ISD). A 'Qualified Supplier' is one that has successfully completed Qualification under the BSC and REC; and has declared that they are now operational under the new arrangements (i.e., they can migrate MPANs to MHHS arrangements and Switch MPANs that are already under MHHS arrangements).
- If a Supplier of Last Resort (SoLR) were to take place during the Migration period, Ofgem would have to give particular consideration to the portfolio and the MHHS status of the losing Supplier, as well as the MHHS status of the gaining Supplier, before determining the appropriate process for moving customers over.
- Switching will not be impacted by the Migration design as Forward and Reverse Migration will support this. Erroneous Transfers (ET) will be resolved following the same processes, what will not be supported in some instances, will be a Suppliers ability to use the same settlement arrangements to support the resolution of an ET. e.g., a Qualified Supplier could not reverse migrate an MPAN back to Legacy.
- Data Aggregators have not been referenced within the migration design as there are no functional changes required to DAs to support either forward or reverse migration. The Registration Service will continue to send D0209s and Suppliers are expected to continue to appoint DAs using the legacy processes and notify the DC of the identity of the DA using legacy processes.

4.2 Risks

- All Suppliers and Agents will need to have made changes to their services and business processes by M11 to support the Migration of MPANs away from their portfolios when a Migration CoS occurs. Parties who have not made that change will cause data quality issues impacting consumers and settlement.
- All Suppliers and Agents wishing to operate the Reverse Migration process (to Switch consumers whose MPAN is under the MHHS arrangements) must have made changes to their services and business processes by M11. Parties who have not made that change will cause data quality issues impacting consumers and settlement.
- Under Legacy arrangements, the CoA process and the CoA coincident with a CoS process can be subject to a high exception rate. By re-using the CoA process for the purposes of Migration, without materially changing the process, there is a risk that Migration is also impacted by a similar level of error.

4.3 Dependencies

- There is a dependency on all Suppliers and Agents to make a minimum amount of change by the start of the Migration period, including Suppliers and Agents that are not planning to be Qualified at the start of the Migration period. They will still need to be able to follow the Migration process where they are losing customers to a Supplier who is going to migrate them to the new arrangements via the Migration CoS process.

- Equally, if unqualified Suppliers intend to Switch consumers that have already migrated to the MHHS arrangements they will need to operate the Reverse Migration process.
- Legacy MOPs and DCs will need to have implemented specific changes, prior to the start of the Migration period, to support forward and Reverse Migration processes.
- The data cleansing activities that have been set out in the Data Cleanse Plan are undertaken to minimise data quality issues.
- The Migration design requires EES to hold and make available a MPAN MHHS Indicator. The means by which this is displayed in the ESS and made available to users will be determined by the REC.

5 Design Detail – Registration Service

5.1 Management of Forward and Reverse Migration Process

The Registration Service will operate as the administering service regarding the management of Migration activities. This service will be the definitive record of the status of each MPAN in respect to the settlement arrangements under which it is operated.

Each individual MPAN will be denoted as operating under either the Legacy Arrangements or the MHHS Arrangements. An MPAN will switch status at a defined point within the processes set out below in section 5.3 of this document.

Within the Migration Period (starting at Programme milestone M11 and ending at milestone M15) the Registration Service will be capable of supporting Legacy and MHHS MPANs – which will also include the Migration from Legacy to MHHS and (in certain cases) the Reverse Migration from MHHS to Legacy.

It is expected that the majority of Forward Migration activities will be initiated by the Supplier for MPANs which are already Registered to them. In which case, the CoA Migration process will be utilised (as set out in section 6 of this document).

Qualified Suppliers may also choose to migrate a MPAN at the same point that they Switch a customer to themselves. This approach will utilise the CoS Migration process (as set out in section 7 of this document).

Suppliers that have not yet become Qualified will continue to be able to Switch consumers (irrespective of a MPANs Legacy or MHHS state) between the Programme M11 and M14 milestones. Where a MPAN is currently under the MHHS arrangements the Registration Service will support this requirement via the Reverse Migration process (as set out in section 8 of this document).

5.2 Migration and Customer Switching

The Registration Service will support 4 Change of Supply scenarios between Programme milestone M11 and M14:

- **MHHS MPAN CoS to a MHHS Qualified Supplier:**
 - Under this scenario the Registration Service will operate under the MHHS Arrangements, as per the BAU MHHS Design.
 - Once an MPAN has been migrated it will not be possible for a Qualified Supplier to initiate the Reverse Migration of an MPAN back to the Legacy arrangements.
 - This scenario will occur infrequently within the first months of the Migration Period but will increase as a percentage of CoS events as the number of MHHS MPANs increases.
- **MHHS MPAN CoS to a Legacy Supplier:**
 - Under this scenario the Registration Service will initiate a Reverse Migration. The MPAN will be automatically reverted to the Legacy Arrangements via the operation of the Reverse Migration process.
 - Reverse Migration will always occur when a Legacy Supplier Switches a MHHS MPAN.

- This scenario will occur infrequently within the first months of the Migration Period but will increase as a percentage of CoS events as the number of MHHS MPANs increases (although as the number of Qualified Suppliers increases this will result in less events).
- **Legacy MPAN CoS to a Legacy Supplier:**
 - Under this scenario the Registration Service will operate the Legacy processes (as per current BSCP 501).
 - This scenario will occur frequently within the first months of the Migration Period but will decrease as a percentage of CoS events as the number of MHHS MPANs increases; and the number of Qualified Suppliers increases.
- **Legacy MPAN CoS to a MHHS Qualified Supplier:**
 - Under this scenario the Registration Service will continue to operate the MPAN under the Legacy arrangements until a point that the Supplier declares that they wish to migrate.
 - The Migration of a MPAN can be coincident with a CoS. To support this capability the Registration Service will send both Legacy and MHHS messages to the Supplier when notified that a Switch is occurring.
 - A Supplier will then choose to Migrate a MPAN coincident with a CoS or continue to operate the MPAN under the Legacy arrangements.
 - This scenario will occur infrequently within the first months of Migration (e.g., only Suppliers that have completed SIT) but will increase as more Participants are Qualified. However, the scenario will then become less frequent as more MPANs are migrated from Legacy to MHHS arrangements.

From the M14 milestone, all Suppliers must have become Qualified. Between M14 and M15 (the end of the Migration Period when all MPANs have been migrated) the Registration Service is expected to only support the following scenarios:

- **MHHS MPAN CoS to a MHHS Qualified Supplier:** As above, this is the enduring MHHS business process and will be the only supported scenario post Migration end at M15.
- **Legacy MPAN CoS to a MHHS Qualified Supplier:** As above, this scenario will cease to occur once all MPANs have been migrated at M15.

From M14 onwards, Reverse Migration will not occur as all Suppliers are assumed to have become MHHS Qualified. If this is not the case, it is assumed that those Suppliers would be prevented from Switching new customers via existing functionality within the Central Switching Service.

The Migration Design does not include a technical solution for preventing a Reverse Migration from occurring post M14. The rationale for this approach is that the initiation of a Reverse Migration occurs when a Legacy Supplier initiates a Switch in the Central Switching Service (CSS). Introducing Migration specific elements into the CSS would be highly complex and costly.

Existing capabilities exist within the CSS to prevent a Supplier from Switching MPANs (e.g., code bodies and LDSOs can utilise existing interfaces and business processes to prevent an individual Supplier MPID from initiating Switches).

The means by which activities should be constrained will be discussed and agreed within the Qualification Workstream.

5.3 Migration Lifecycle

The Registration Service will manage the Migration lifecycle of an MPAN. The lifecycle will differ between a Forward Migration and a Reverse Migration as set out below.

5.3.1 Forward Migration

1. It is expected that the Supplier will consult data available to them (e.g., EES, MTDs etc.) to validate that the MPAN is in a fit state to migrate. Certain quality criteria may be defined, within the Migration Workstream, which would determine if a MPAN should be migrated. The Migration Design is agnostic of this, i.e., no requirements have been developed which would require the Registration Service to validate a request from a Supplier to initiate a Migration.
2. As a minimum, the Supplier will validate that the Market Segment held within the Registration Service is correct to support the Migration of the MPAN, as the Registration Service would reject the appointment of Agents if different.
3. The Supplier will initiate the Forward Migration of a MPAN via the submission of an IF-031 to the Registration Service
4. The Migration will complete when at least one Service Provider (either the MS or the DS) appointment becomes current (denoted by the transmission of an IF-036 Supplier, Electricity Enquiry Service, LDSO and the relevant Service Provider). If either appointment were to fail, the Supplier would need to submit a new appointment which would be accepted by the Service Provider following the standard MHHS process.
5. The transmission of an IF-036 will be a definitive statement to each service that a Forward Migration has occurred and the MPAN is now operating under the MHHS arrangements.
6. The Registration Service will not automatically lapse IF-031's after a certain time period. Therefore, it is essential that MS / DS respond with an IF-034 within their usual SLAs to prevent MPANs becoming 'stuck' (as D flows and IF events will be rejected until the Migration completes).
7. In the case of Related MPANs, these will be treated in the same way that they are treated in the BAU Design. An IF-031 will be sent to the Primary MPAN to serve as the instruction to begin Forward Migration and the Secondary MPAN will automatically be migrated alongside the Primary MPAN (without requiring a second IF-031 to be sent). The Registration Service will send separate IF-036's for the Primary and Secondary MPANs at the same point in time. The same MS and DS must be appointed to both MPANs.
8. When the IF-036 is sent, one of the recipients of this message is Elexon Central Systems who will use this message as a signal to start settlement activities for the MPAN that has been migrated.
9. A Migration will complete unless the following events occur:
 - a. A Pending Registration is received by the Registration Service from the Central Switching Service (CSS). In this case the appointment would be rejected. This Process should run until M15 when all MPANs should have been migrated.
 - b. Neither of the Service Providers have accepted the appointment request and there have been no further requests for an Agent appointment for that date triggered by the incumbent Supplier.
 - c. A Cancelled Registration is received by the Registration Service from the CSS. Suppliers are likely to face quotas for Forward Migration via both the CoS and CoA processes. These quotas are yet to be defined and will be discussed within the Migration Working Group.
10. Once an MPAN has begun migration, any legacy flows relating to the MPAN will be rejected by the Registration Service.

5.3.2 Reverse Migration

1. The incoming Supplier will be expected to check the MHHS status of an MPAN prior to initiating a Switch. For an unqualified Supplier, between M11 and M14, they will perform this check to determine if the Legacy processes or Reverse Migration process is to be utilised.

2. The Registration Service will initiate a Reverse Migration when a Pending Registration for an Unqualified Supplier, is received from the CSS; for a MPAN operated under the MHHS arrangements, up until M14.
3. The Reverse Migration will complete when a Secured Active Registration is received by the Registration Service from the CSS and an IF-003 is sent to the Elexon Central Systems, outgoing Supplier, Electricity Enquiry Service, LDSO and the relevant Service Providers.
4. The receipt of an IF-003 will be the definitive statement to each service that a Reverse Migration has occurred and the MPAN is now operating under the Legacy arrangements.
5. At this point the EES will revert the MPAN to legacy.
6. A Reverse Migration will complete unless the following events occur:
 - a. A Cancelled Registration is received by the Registration Service from the CSS.
7. A Reverse Migration can only take place via a CoS.
8. Once an MPAN has begun Reverse Migration, any DIP flows relating to the MPAN will be rejected by the Registration Service.
9. The incoming Supplier will appoint the MOP, DC and DA using the legacy D0155/D0153 process under which agents will accept or reject an appointment using the D0011 or the D0261.
10. The supplier will inform the incoming NHHDC of the correct settlement data to be utilised via the legacy process of sending a D0052.

6 Design Detail – Forward Migration - CoA

6.1 Traditional Metering

Under this scenario a Supplier chooses to migrate a MPAN that has a Traditional meter installed, which they are currently Registered to, from Legacy to MHHS arrangements.

6.1.1 Initiation and Acceptance of Appointment

1. The Forward Migration of a Traditional meter via the CoA process will be started by the incumbent Supplier. When a Supplier determines that they want to migrate a MPAN, an IF-031 will be sent by the incumbent Supplier to the Registration Service (via the DIP)
2. The IF-031 can contain one of two new enumerated values within the 'Service Provider Appointment Scenario' data item: "MCS" for a Forward Migration CoS and "MCA" for a Forward Migration CoA. More detail can be found in the Required Interface Changes to Support Migration Design section. In the case of a Forward Migration CoA, the value "MCA" will be utilised.
3. The Registration Service will operate a Migration-specific set of business rules when validating this request which differ to the BAU rules for the treatment of associated Import and Export MPANs (as described further in the definition of the IF-031 in this document). Related MPANs will be treated as per the BAU MHHS arrangements.
4. For the purposes of the CoA Migration process, the below business rules should be followed by Suppliers regarding the lead time between the submission date of the IF-031 and the requested effective from date of the Migration.
 - a. An effective from date from Same Day +1 up to a maximum of 28 calendar days (inclusive of the 28th day) in the future is permissible.
 - b. Same day or Retrospective appointments should not be utilised when performing a CoA Migration, with the exception being a resolution of an error.

- c. The CoA Migration process will be ended if a customer chooses to Switch to a new Supplier (as described further in section 5.3 Migration Lifecycle). A lower lead time would mitigate this risk so may be more preferable to Suppliers.
5. The MHHS BAU process for informing the incoming Metering Service and Data Service of a CoA will be followed for their appointment. As no outgoing Metering Service and Data Service exist those BAU processes will not occur. This means that the IF-037 will not be sent by the Registration Service to de-appoint the outgoing Metering Service and the IF-037 will not be sent to de-appoint the outgoing Data Service.
6. The D0170 will be generated by the Registration Service following the acceptance of an appointment by the DS and MS respectively. One D0170 message will be generated for each appointment accepted i.e., if both DS and MS accept, two D0170's will be generated. The D0170 will not be sent in 'near real time' and instead will be processed as part of the MPRS overnight batch run which runs at 2300 hours on working days only. The batch run begins at 2300 hours so D0170's will be received by Suppliers from this point on into the early hours of the following day. If the PUB-034 is not received before 2300 hours, it will be processed the next working day by 2300 hours.
7. The D0170 data flow is structured in the same manner as a Legacy flow, with the additional rules:
 - a. The 'Requested Action Code' data item value must be "24" (MHHS Migration CoA), which will denote that a Migration is occurring. This is the only instruction that a Meter Operator (MOP) and Data Collector (DC) will receive to inform them that the CoA Migration Process must be followed in place of a normal Legacy CoA process.
 - b. If the code is "24" this will indicate to the MOP and DC that the MPID values for 'New Meter Operator ID' and 'New Data Collector ID' represent the new Metering Service and new Data Service respectively.
8. Following the acceptance of the appointments, the Supplier will also send a D0151 to the outgoing MOP (As shown following Step 95 in BPM-002-Change of Service - Metering Service - Forward Migration) and a D0151 to the outgoing NHHDC (As shown following Step 95 in BPM-003-Change of Service - Data Service - Forward Migration).
9. The D0151 will indicate to the outgoing MOP and NHHDC, that a CoA is taking place and the data item 'Termination Reason' (J0279) should contain the value 'CA' as per a Legacy CoA de-appointment.
10. The SLAs for the sending of the D0151 to the ongoing MOP will not change from those set out within the REC Metering Services Schedule. For Traditional NHH metering the D0151 should be sent within 5 working days of the acceptance of an appointment by the new Metering Service.
11. The SLAs for the sending of the D0151 to the outgoing NHHDC will not change from those set out in BSCP504, which require the message to be sent 3 working days prior to the effective date of the CoA.

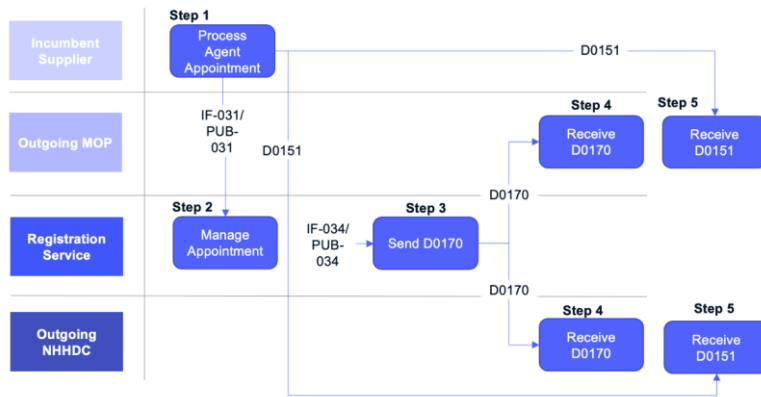

Process Diagram 1: Traditional Metering – Initiation and Acceptance of Appointment

12. If subsequent IF-031's are received before the initial Migration completes (Migration completion is indicated through the send of an IF-036), the original IF-031 should be lapsed and the IF-031 with the most recent timestamp should be used instead. In this case, an IF-035 would be sent immediately to cancel the Migration.
13. If MPAN state changes to terminated, an IF-035 would be sent which would cancel the Migration. This IF-035 would be sent at the same time as a Cancellation message was sent by the CSS. In this case, future IF-031s are to be rejected.
14. The Registration Service will send the IF-036 at the Service Appointment effective from date. The send of the IF-036 will act as the definitive indicator that a Forward Migration has completed.

6.1.2 Transfer of MTDs

1. Once the outgoing MOP has received the D0170, they will then share MTDs with the new Metering Service via a D0149/D0150. The MS then processes the MTDs and shares them with the incumbent Supplier and new DS via a D0149/D0150 (as per the BAU MHHS Process).
2. The existing SLAs set out within the REC Metering Services Schedule will continue to be applicable to the outgoing MOP who should send the D0150/D0149 within 5 working days following receipt of the D0170.

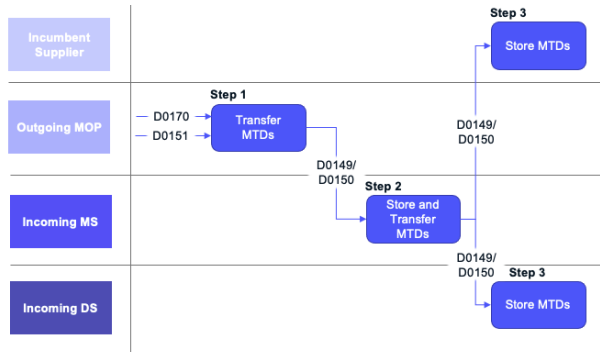

Process Diagram 2: Traditional Metering – Transfer of MTDs

6.1.3 Transfer of Reads

1. Following Step 260 in BPM-003 – Change of Service – Data Service – Forward Migration, the incumbent Supplier will share a meter read via a D0010 with the outgoing DC if they have a meter reading obtained within the last 8 days.
2. When the outgoing DC has received this D0010 along with the D0170 from the Registration Service, they will then validate the read; or if they have not received a read, they will generate a deemed read for the date of their effective to date.
3. The process for deeming readings will be the same as that currently undertaken for Change of Measurement Class from NHH to HH.
4. Using this read, the outgoing DC will then send a D0019 / D0010 to the incumbent Supplier and a D0010 to the LDSO, who in turn, may use this to close out the customer billing for the MPAN under the old NHH arrangements. The generated D0010 will be populated with the following values:

a. Reading Type (J0171) = UFinal

b. Meter Reading Reason Code = 28 (Forward Migration CoA)

5. The D0019 will be generated to contain an annualised advance (AA) only, no estimated annual advance (EAC) will be created (following the same approach as NHH to HH Change of Measurement Class). The AA will be created to the Effective to Settlement Date of the DCs appointment.
6. The Supplier will send the same read to the incoming DS via a D0010. The incoming DS will then use this read as a start read for the new MHHS arrangements. The generated D0010 will be populated by the Supplier with the following values:

a. Reading Type (J0171) = UInitial

b. Meter Reading Reason Code = 28 (Forward Migration CoA)

7. To ensure the quality of NHH and MHHS settlement activity it is essential that the same reading is utilised for opening and closing the Legacy and MHHS arrangements.
8. The Migration Workstream will consider if additional monitoring is required to ensure that the same readings are utilised.

Commented [R(1)]: DIN-985

Formatted: No bullets or numbering

Commented [R(2)]: DIN-985

Formatted: No bullets or numbering

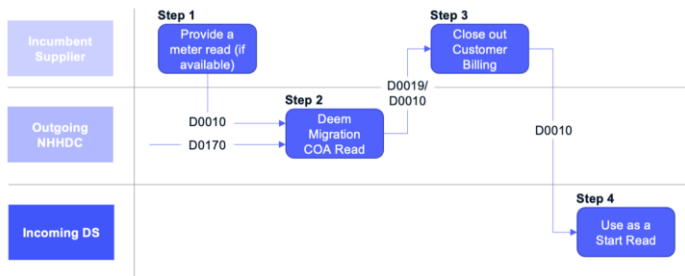

Process Diagram 3: Traditional Metering – Transfer of Reads

6.2 Advanced Metering (NHH)

Under this scenario a Supplier chooses to migrate a MPAN which they are currently Registered to, that has an Advanced meter installed from Legacy NHH settlements to MHHS arrangements.

6.2.1 Initiation and Acceptance of Appointment

The same processes as set out in section 6.1.2 of this document (for Traditional Metering) will be followed for Advanced Meters which are currently settled NHH.

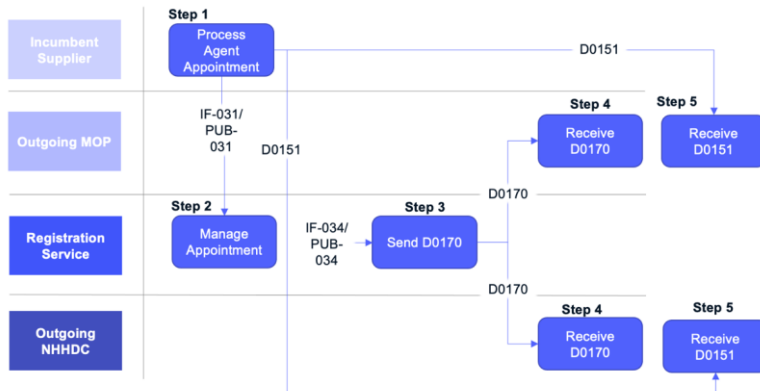

Process Diagram 4: Advanced (NHH) Metering – Initiation and Acceptance of Appointment

6.2.2 Transfer of MTDs

1. Once the outgoing MOP has received the D0170, they will then share MTDs with the new Metering Service via a D0268. The MS then processes the MTDs and shares them with the incumbent Supplier and new DS via a D0268 (as per the MHHS BAU Design).
2. The existing SLAs set out within the REC Metering Services Schedule associated to NHH MOPs will continue to be applicable to the outgoing MOP, who should send the D0268 within 5 working days following receipt of the D0170.

- The outgoing MOP will be required to send a D0268 for all Advanced meters when notified via the D0170 that a Migration is occurring. The MOP will convert the current MTDs (which they will hold in a NHH D0150/D0149 and a D0313) into a D0268 prior to sending to the new Metering Service.

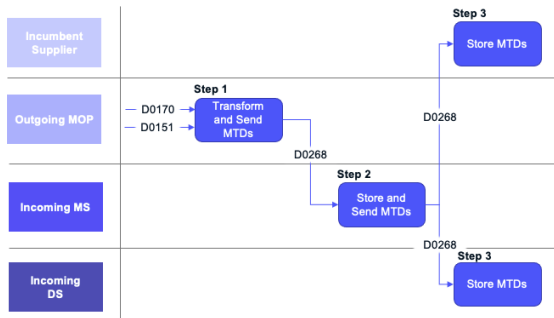

Process Diagram 5: Advanced (NHH) Metering – Transfer of MTDs

6.2.3 Transfer of Readings

For an Advanced meter which is currently settled NHH there is no requirement for the NHHDC to share any reading data with the incoming DS. The rationale for this is that the new DS will not be able to make use of a D0010, as their processes require HH profile data not register readings.

- The NHHDC will obtain a meter reading for the date of their de-appointment via remote communications or via other means. The reading needs to be taken for the date of their Effective To Date.
- The D0170, sent from the Registration Service to the NHHDC, will inform the DC that the Forward Migration process is to be operated, via the 'Requested Action Code' data item value "24" (MHHS Migration CoA). The NHHDC will then operate different processes to those normally operated under the Legacy design.
- If the outgoing DC was able to obtain a read they will then validate the read; or if they have not received a read, they will generate a deemed read for the date of their effective to date.
- The process for deeming readings will be the same as that currently undertaken for Change of Measurement Class from NHH to HH.
- Using this read, the outgoing DC will then send a D0019 / D0010 to the incumbent Supplier and a D0010 to the LDSO, who in turn will may this to close out the customer billing for the MPAN under the old NHH arrangements. The generated D0010 will be populated with the following values:
 - Reading Type (J0171) = UFinal
 - Meter Reading Reason Code = 28 (Forward Migration CoA)
- The D0019 will be generated to contain an annualised advance (AA) only, no estimated annual advance (EAC) will be created (following the same approach as NHH to HH Change of Measurement Class). The AA will be created to the Effective to Settlement Date of the DCs appointment.
- For an Advanced meter currently settled NHH neither the Supplier nor the Outgoing NHHDC will share readings with the incoming DS.
- The DS will have been informed that their appointment is associated to a Migration via the received DIP appointment messages so will commence its operations, in the knowledge that the BAU MHHS

Commented [R(3)]: DIN-985

Formatted: No bullets or numbering

Process will not occur (e.g., they can't request consumption history from the DIP). However, the other steps in BPM003c and subsequent BPM004 and BPM005 process will occur.

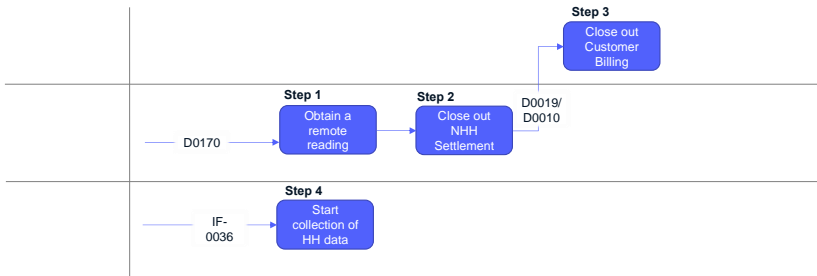

Process Diagram 6: Advanced (NHH) Metering – Transfer of Readings

6.3 Advanced Metering (HH)

Under this scenario a Supplier chooses to migrate a MPAN which they are currently Registered to, that has an Advanced meter installed, from Legacy HH settlements to MHHS arrangements.

6.3.1 Initiation and Acceptance of Appointment

The same processes as set out in section 6.1.2 of this document (for Traditional Metering) will be followed for Advanced Meters which are currently settled HH.

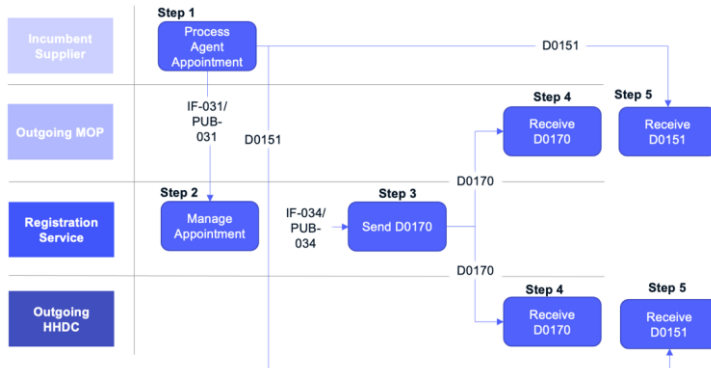

Process Diagram 7: Advanced (HH) Metering – Initiation and Acceptance of Appointment

6.3.2 Transfer of MTDs

1. Once the outgoing MOP has received the D0170, they will then share MTDs with the new Metering Service via a D0268. The MS then processes the MTDs and shares them with the incumbent Supplier and incoming DS via a D0268.

- The existing SLAs set out within the REC Metering Services Schedule associated to HH MOPs will continue to be applicable to the outgoing MOP, who should send the D0268 within 5 working days following receipt of the D0170.

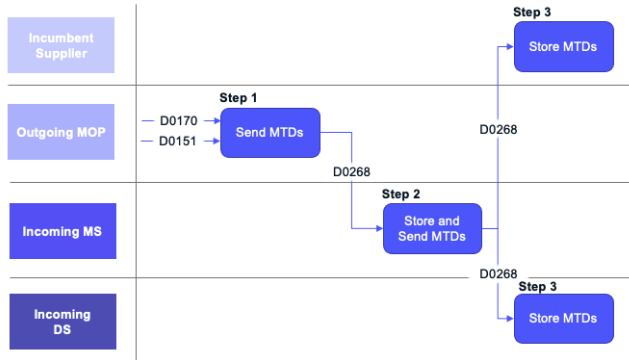

Process Diagram 8: Advanced (HH) Metering – Transfer of MTDs

6.3.3 Transfer of Readings

For an Advanced meter which is currently settled HH, there is a requirement for the HHDC to share 3 months of historical HH profile data with the incoming DS when available. The rationale for this is that the new DS will be able to make use of the HH profile data within any estimation activity which may be required.

- Following the receipt of the D0170 from the Registration Service by the outgoing DC, as shown in 6.3.1 above, the outgoing DC will send a D0036 to the incoming DS which contains the historic HH data for the meter. This will then be used by the new DS to operate the MPAN under the new MHHS arrangements by providing a historical view of the MPAN's consumption. Assisting with future estimation.
- The HHDC will also send data to the Supplier and LDSO as per the Legacy processes, ensuring that they both receive complete HH data to the HHDCs Effective To Date (via a D0036 and/or D0275).

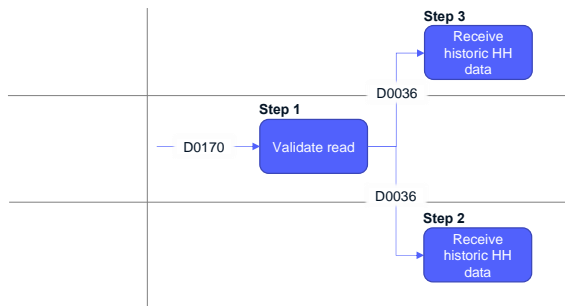

Process Diagram 9: Advanced (HH) Metering – Transfer of Reads

6.4 Smart Metering (NHH)

Under this scenario a Supplier chooses to migrate a MPAN which they are currently Registered to, that has a Smart meter installed from Legacy NHH settlements to MHHS arrangements.

6.4.1 Initiation and Acceptance of Appointment

The same processes as set out in section 6.1.2 of this document (for Traditional Metering) will be followed for Smart Meters which are currently settled NHH.

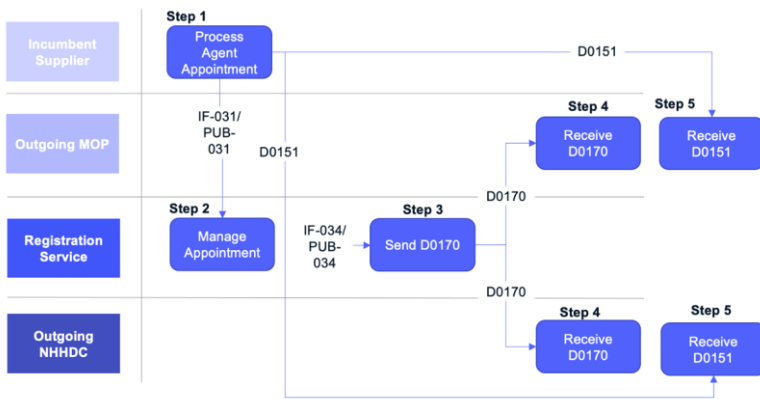

Process Diagram 10: Smart (NHH) Metering – Initiation and Acceptance of Appointment

6.4.2 Transfer of MTDs

1. The receipt of the D0170 containing a 'Requested Action Code' with a data item value set to "24" (MHHS Migration CoA), will denote that no further action is required if the meter type related to the MPAN is a smart meter.
2. For a smart meter, the outgoing MOP will not be required to follow any additional steps following the receipt of this D0170. Instead, the relevant MTDs will be shared with the new Metering Service by the Registration Service via the BAU MHHS CoA (MS) process, where they receive them via an IF-036 which is sent via the DIP to the new MS.

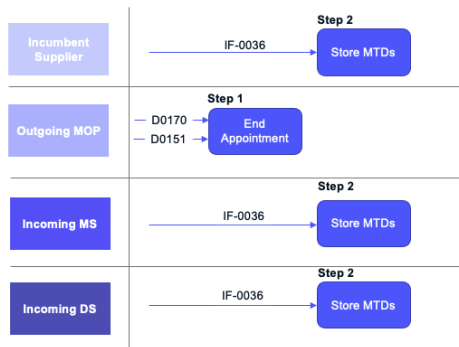

Process Diagram 11: Smart (NHH) Metering – Transfer of MTDs

6.4.3 Transfer of Reads

1. Following Step 260 in BPM-003 – Change of Service – Data Service – Forward Migration, the incoming Data Service will retrieve a Midnight read from the Smart meter and share this with the incumbent Supplier, via an IF-041 (as per the MHHS BAU Process).
2. The incumbent Supplier will then validate this read and will also take their own read and send it via a D0010 to the outgoing NHHDC.
3. Where no comms exist, the Supplier should estimate a read in place of an actual read obtained from the meter.
4. The D0010 sent from Supplier to NHHDC will contain the active TOU Registers (mapped to the active SSC). The generated D0010 will be populated by the Supplier with the following values:
 - a. Reading Type (J0171) = UFinal
 - b. Meter Reading Reason Code = 28 (Forward Migration CoA)
5. Following the receipt of the D0170 by the outgoing DC, referenced in section 6.4.1, and the receipt of the D0010, the outgoing DC will validate the read and create an AA. They will then share this read with the incumbent Supplier via a D0010/D0019 and the incumbent Supplier will use this to close out customer billing.
6. The D0010 sent from NHHDC to Supplier will contain the following values:
 - a. Reading Type (J0171) = UFinal
 - b. Meter Reading Reason Code = 28 (Forward Migration CoA)
7. If required, the NHHDC will follow the process set out in section 6.2.3 and deem a reading if a D0010 is not received from the Supplier in a timely manner or for the date required (no read received within +/- 5 working days).

Commented [R(4)]: DIN-985
Formatted: No bullets or numbering

Commented [R(5)]: DIN-985
Formatted: No bullets or numbering

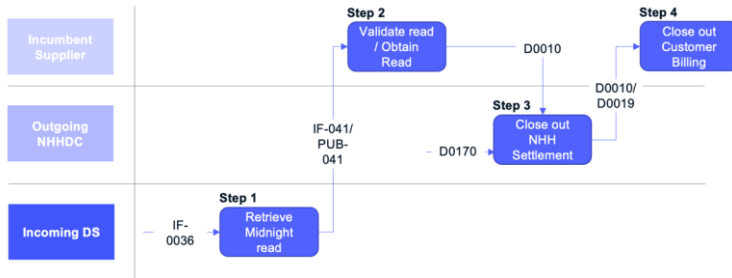

Process Diagram 12: Smart (NHH) Metering – Transfer of Reads

6.5 Smart Metering (HH)

Under this scenario a Supplier chooses to migrate a MPAN, which they are currently Registered to, that has a Smart meter installed from, Legacy HH settlements to MHHS arrangements.

6.5.1 Initiation and Acceptance of Appointment

The same process as set out in section 6.4.1 for smart metering (NHH) shall be followed.

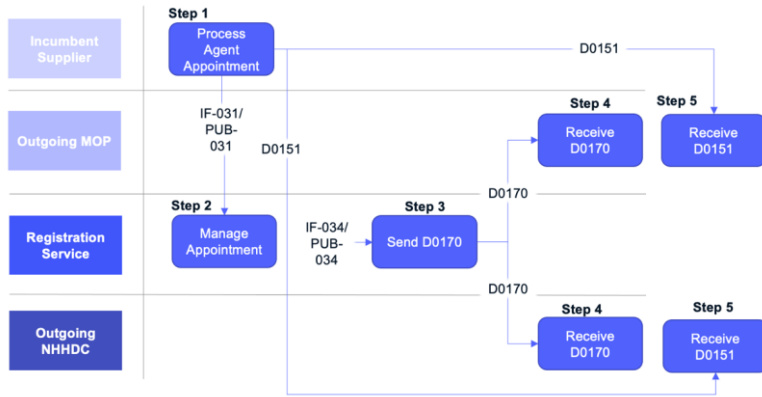

Process Diagram 13: Smart (HH) Metering – Initiation and Acceptance of Appointment

6.5.2 Transfer of MTDs

The same process as set out in section 6.4.2 for smart metering (NHH) shall be followed.

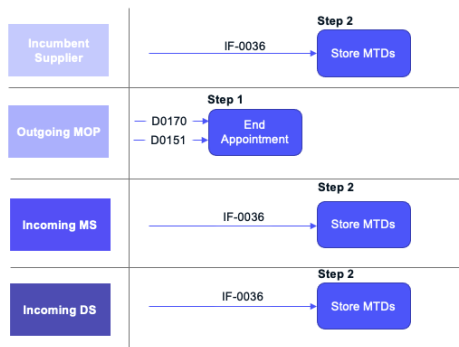

Process Diagram 14: Smart (HH) Metering – Transfer of MTDs

6.5.3 Transfer of Reads

1. There is no requirement for reads to be shared between the HHDC and the new DS within the Migration process for Smart meters settled HH.
2. The HHDC will collect data for the day of their appointment, but they will follow the standard BSCP502 process for sharing data with other parties. The HHDC will be required to ensure that there is no data shared with the new DS if the Smart meter is settled half-hourly.
3. The incoming DS will begin collection processes following the BAU Design, although the DIP appointment flows will have notified the DS that the MHHS BAU CoS process (as set out in BPM003c) will not be followed as no ongoing DS will exist.

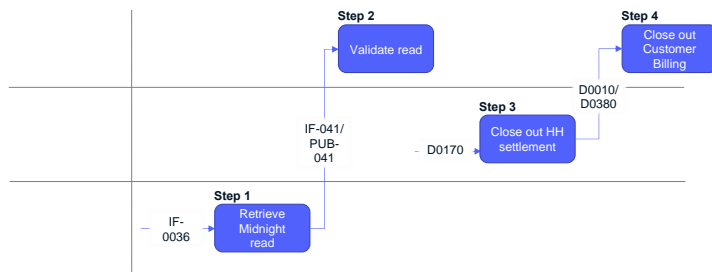

Process Diagram 15: Smart (HH) Metering – Transfer of Reads

6.6 Unmetered MPANs

Under this scenario a Supplier chooses to migrate an Unmetered MPAN, which they are currently registered to from Legacy HH settlements to MHHS arrangements.

6.6.1 Initiation and Acceptance of Appointment

1. The Supplier will de-appoint the MA via the D0151 or other agreed means. Within the D0151, the data item 'Termination Reason' (J0279) should contain the value 'CA' as per a Legacy CoA de-appointment.
2. For unmetered sites, the Registration Service will not send a D0170 to the MA, as the MA is not required to send any data to the new MS (UMSO) or DS (UMDS).
3. The outgoing HHDC will receive a D0170 to notify them that a Migration is occurring so that they operate the required Migration process.

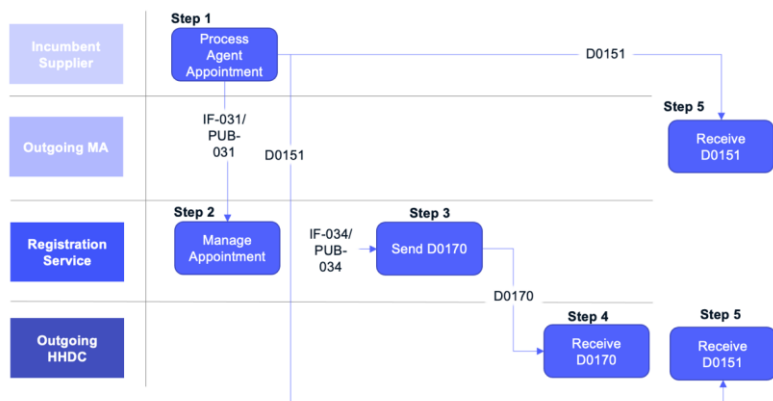

Process Diagram 16: Unmetered MPAN – Initiation and Acceptance of Appointment

6.6.2 Transfer of Inventory Data

1. Once the outgoing MA has received the D0151, they will stop operations from their Effective To Date.
2. The Incoming MS (UMSO) will then share the inventory with the Incoming DS (UMDS), following the MHHS BAU process.
3. This data will be provisioned using the Legacy data flow D0388.

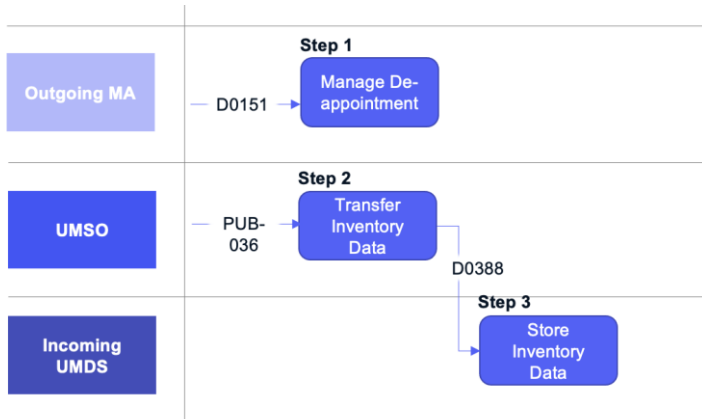

Process Diagram 17: Unmetered MPAN – Transfer of Inventory Data

6.6.3 Transfer of Readings

For an Unmetered MPAN there is no requirement for the HHDC to share 3 months of historical HH profile data with the incoming DS.

1. Following the receipt of the D0170 from the Registration Service and a D0151 from the Supplier, the outgoing DC will collect data to their Effective To Date and provide through to those parties that require it following the legacy processes (via the D0036 and/or D0275 as agreed).

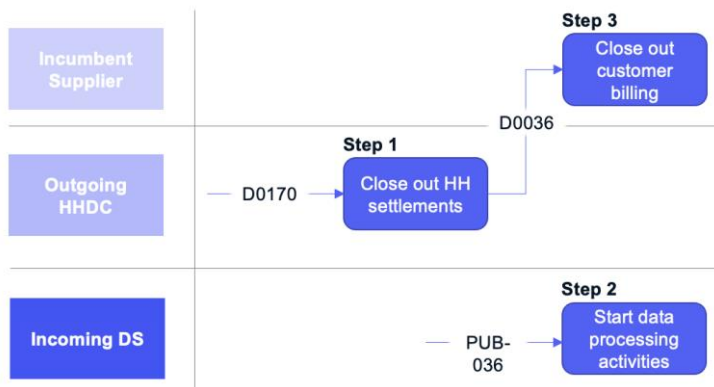

Process Diagram 18: Unmetered MPAN – Transfer of Reads

6.7 Migration Timings (COA)

The new message choreography, which will apply to CoA migration messages only, is described through the below table and diagram. Industry participants should send the relevant messages only during the time windows indicated below. If messages are sent in accordance with these time windows, the receiving party is under obligation to process the message and send any resulting messages by a specific deadline. If messages are sent outside of these time windows, the receiving party is under no obligation to process these by the specified deadline.

For more detail on this change, please refer to Section 8.4 of the Migration Thresholds Document.

Process Description	CoA Migration Messages Sent	Window to Undertake Activity	Processing Deadline Conditionality
Suppliers to submit migration initiation messages	IF-031	05:00 – 12:00	N/A
Registration Services to issue all resulting IF-032's and IF-033's	IF-032, IF-033	05:00 – 17:00	Processing deadline of 17:00 only applies to messages resulting from IF-031's received between 05:00 – 12:00
Service Providers to process all IF-033's and send resulting IF-034's	IF-034	05:00 – 23:00	Processing deadline of 23:00 only applies to messages resulting from IF-033's received before 17:00
Registration Services to process all IF-034's and send resulting IF-035's	IF-035	05:00 – 23:00 and overnight batch run	Processing deadline of end of overnight batch run only applies to messages resulting from IF-034's received before 23:00

Commented [ZH(6): DIN-1022

Formatted: Font: (Default) +Body (Arial)

Formatted: Font: (Default) +Body (Arial), 11 pt, Font color: Auto

Formatted: MHHS Body, Space After: 1 pt, Line spacing: At least 0 pt

Formatted: Font: 11 pt, Font color: Auto

Formatted: Font: (Default) +Body (Arial), 11 pt

Formatted: MHHS Body, Centered

Formatted: Font: (Default) +Body (Arial), 11 pt

Formatted: MHHS Body, Centered

Formatted: Font: (Default) +Body (Arial), 11 pt

Formatted: MHHS Body, Centered

Formatted: MHHS Body

Formatted: Font: (Default) +Body (Arial), 11 pt

Formatted: MHHS Body, Centered

Formatted: MHHS Body

Formatted: Font: (Default) +Body (Arial), 11 pt

Formatted: MHHS Body, Centered

Formatted: MHHS Body

Formatted: Font: (Default) +Body (Arial), 11 pt

Formatted: Space After: 6 pt, Line spacing: At least 13 pt

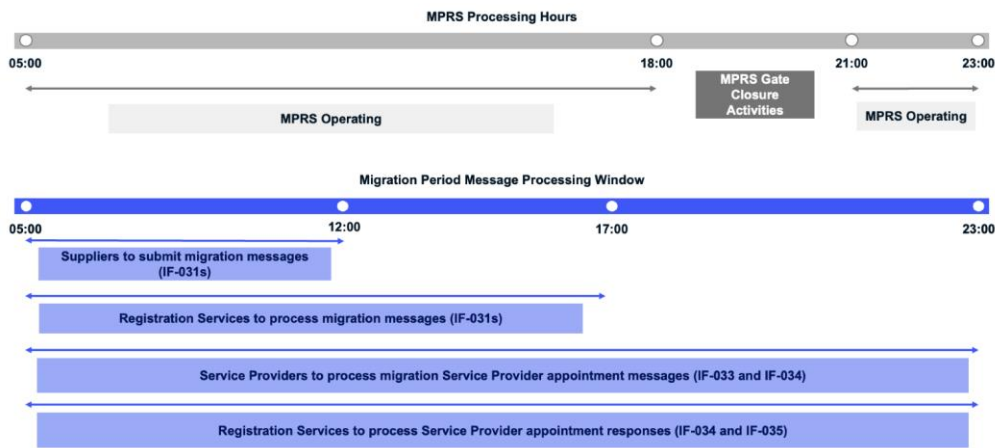

Please note the below in relation to these conditions:

These processing windows and deadlines will apply to CoA migration messages only. All other messages are considered part of BAU activities and will not be subject to these conditions.

These conditions will not be enforced through any system or functional changes. A Supplier could still physically send a CoA migration IF-031 post-12:00, however the receiving Registration Service will not be obliged to process this before 17:00.

Similarly, in the case of message rejection, CoA migration IF-031 re-tries will be permitted to be sent outside the 05:00-12:00 window, however the receiving Registration Service will not be obliged to process these before 17:00.

All times are in local time.

Formatted: Font: (Default) +Body (Arial), 11 pt

Formatted: MHHS Body

Formatted: MHHS Body, No bullets or numbering

Formatted: Font: (Default) +Body (Arial), 11 pt, Font color: Black

Formatted: Font: (Default) +Body (Arial), 11 pt

Formatted: Font: (Default) +Body (Arial), 11 pt, Font color: Black

Formatted: Font: (Default) +Body (Arial), 11 pt

Formatted: Font: (Default) +Body (Arial), 11 pt, Font color: Black

Formatted: Font: (Default) +Body (Arial), 11 pt

Formatted: Font: (Default) +Body (Arial), 11 pt, Font color: Black

Formatted: Space After: 6 pt, Line spacing: At least 13 pt

7 Design Detail – Forward Migration - CoS

7.1 Traditional Metering

Under this scenario a MHHS Qualified Supplier chooses to migrate a MPAN, that has a Traditional meter installed from Legacy NHH settlements to MHHS arrangements, coincident with a Switch that they have initiated.

7.1.1 Initiation and Acceptance of Appointment

1. Following the receipt of a Pending Registration Synchronisation message from the CSS, the Registration Service will send the new Supplier the registration details of the old Supplier and will confirm the registration of the Meter point via a D0217 / D0260 and IF-002.
2. The new Supplier receives the D0217 / D0260 and a PUB-002 from the Registration Service (via the DIP), the new Supplier will choose whether to migrate the MPAN or to continue operating under Legacy arrangements. Registration Service to send the D0217/D0260 the next working day at the very latest after the IF-002 (although in most cases the messages will be sent only a few hours apart).

3. The Supplier will declare to the Registration Service, that they wish to migrate the MPAN by sending an IF-031. The IF-031 will contain two new enumerated values within the 'Service Provider Appointment Scenario' data item: "MCS" for a Migration CoS and "MCA" for a Migration CoA. More detail can be found in the Required Interface Changes to Support Migration Design section of this document.
4. The Registration Service will operate a Migration specific set of business rules when validating this request which differ to the BAU rules for the treatment of associated Import and Export MPANs (as described further in section 10.2 (MHHS Interface Specification Changes) of this document). Related MPANs will be treated as per the BAU MHHS arrangements.
5. The Migration of the MPAN within the Registration Service will then continue via the steps laid out in the BPM-002-Change of Service – Metering Service – Forward Migration and BPM-003-Change of Service – Data Service – Forward Migration process maps to appoint the incoming Data Service and Metering Service.
6. Following Step 100 in BPM-002-Change of Service – Metering Service – Forward Migration, the Registration Service will send a D0170 to the outgoing MOP, informing them that the CoS that is taking place is a Forward Migration CoS.
7. Similarly, following Step 100 in BPM-003 – Change of Service – Data Service – Forward Migration, the Registration Service will send a D0170 to the outgoing DC, informing them that the CoS that is taking place is a Forward Migration CoS.
8. The D0170 will be generated by the Registration Service following the acceptance of an appointment by the DS and MS respectively. One D0170 message will be generated for each appointment accepted i.e., if both DS and MS accept, two D0170's will be generated. The D0170 will not be sent in 'near real time' and instead will be processed as part of the MPRS overnight batch run which runs at 2300 hours on working days only. The batch run begins at 2300 hours so D0170's will be received by Suppliers from this point on into the early hours of the following day. If the PUB-034 is not received before 2300 hours, it will be processed the next working day at 2300 hours.
9. The D0170 data flow is structured in the same manner as a Legacy flow, with the additional rules:
10. The 'Requested Action Code' data item value must be set to "25" (MHHS Migration CoS), which will denote that a Migration is occurring. This is the only instruction that a Meter Operator (MOP) will receive to inform them that the CoS Migration Process must be followed in place of a normal Legacy CoS process.
 - a. If the code is "25" this will indicate that to the Agent that the MPID values for 'New Meter Operator ID' and 'New Data Collector ID' represent the new Metering Service and new Data Service respectively.

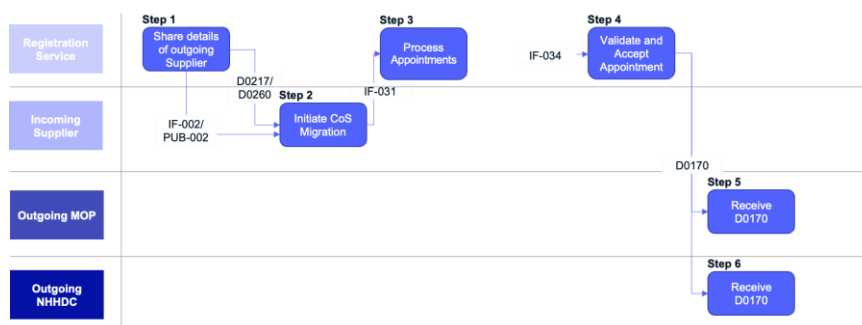

Process Diagram 19: Traditional Metering CoS – Initiation and Acceptance of Appointment

7.1.2 Transfer of MTDs

1. The process continues on BPM-002-Change of Service – Metering Service – Forward Migration, the outgoing Supplier to issue a D0151 to the old MOP; this message will inform the MOP that they are to be de-appointed from servicing the MPAN and the data item 'Termination Reason' (J0279) should contain the value 'LC' as per Legacy arrangements. In this CoS scenario, data item 'New Supplier ID' (J1194) must also be populated.
2. The D0151 should be issued by the Effective From Date of the Switch, by the outgoing Supplier (as per the Legacy SLA).
3. Once the outgoing MOP has received the D0170, they will then follow the legacy process SLAs (5 working days) for sharing MTDs with the new Metering Service whereby a D0149/D0150 is sent to the new MS who processes the MTDs and shares them with the incoming Supplier and the incoming DS via a D0149/D0150.

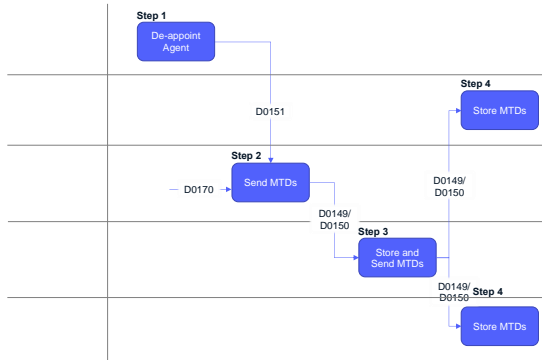

Process Diagram 20: Traditional Metering CoS – Transfer of MTDs

7.1.3 Transfer of Reads

1. Following Step 260 in BPM-003 – Change of Service – Data Service – Forward Migration, the incoming Supplier will attempt to retrieve a CoS read and share this with the outgoing Supplier via a D0010.
2. The D0010 sent from Supplier will contain the active TOU Registers (mapped to the active SSC). The generated D0010 will be populated by the Supplier with the following values:

a. ~~Reading Type (J0171) = VInitial~~

- b. ~~Meter Reading Reason Code = 29 (Forward Migration CoS)~~

3. The outgoing Supplier will then validate and share this reading with the outgoing DC via a D0010.

4. The D0010 sent from Supplier to NHHDC will contain the active TOU Registers (mapped to the active SSC). The generated D0010 will be populated by the Supplier with the following values:

a. ~~Reading Type (J0171) = VFinal~~

- b. ~~Meter Reading Reason Code = 29 (Forward Migration CoS)~~

Commented [R(7)]: DIN-985

Formatted: No bullets or numbering

Commented [R(8)]: DIN-985

Formatted: No bullets or numbering

5. When the outgoing DC has received this D0010 along with the D0170 from the Registration Service, they will then validate the read or if they have not received a D0010, or cannot validate the read, they will generate a deemed reading following the rules set out in BSCP504 for a Change of Supplier.
6. If a reading has not been received from the outgoing Supplier (in place of the Legacy interactions which would occur between old and new NHHDC) the outgoing NHHDC will follow the Legacy SLAs for creating a deemed read for the CoS.
7. The outgoing NHHDC will then send a D0086 / a D0019 to the outgoing Supplier and the LDSO as per existing Legacy processes. The D0019 created will contain an AA to the DCs Effective To Date and will not contain a forward EAC.
8. If there are any exceptions where the readings do not align, the D0300 Process (Disputed Reads Process) should be followed. The incoming Supplier will then share this read with the incoming DS via a D0010 and the incoming DS will use this as a replacement start read.

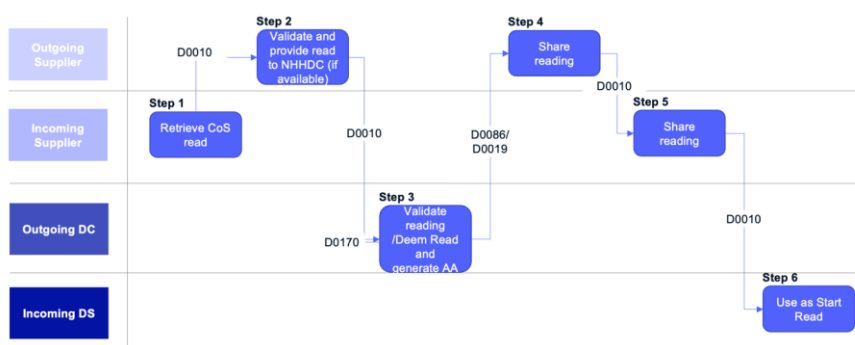

Process Diagram 21: Traditional Metering CoS – Transfer of Reads

7.2 Advanced Metering (HH)

Under this scenario a MHHS Qualified Supplier chooses to migrate a MPAN that has an Advanced meter installed, from Legacy HH settlements to MHHS arrangements, coincident with a Switch that they have initiated.

7.2.1 Initiation and Acceptance of Appointment

The same processes as set out in section 7.1.2 of this document (for Traditional Metering) will be followed for Advanced Meters which are currently settled HH.

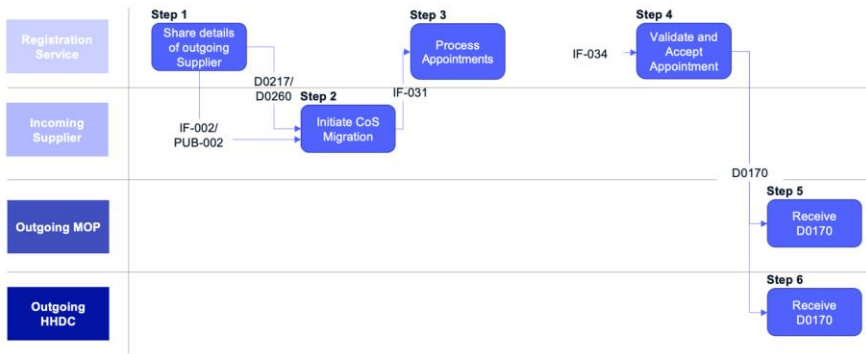

Process Diagram 22: Advanced (HH) Metering CoS – Initiation and Acceptance of Appointment

7.2.2 Transfer of MTDs

1. The process continues on BPM-002-Change of Service – Metering Service – Forward Migration, the outgoing Supplier to issue a D0151 to the old MOP (by the Supply Start Date); this message will inform the MOP that they are to be de-appointed and the data item 'Termination Reason' (J0279) should contain the value 'LC' as per Legacy arrangements. In this CoS scenario, data item 'New Supplier ID' (J1194) must also be populated.
2. The existing SLAs set out within the REC Metering Services Schedule associated to HH MOPs sending of MTDs will continue to be applicable to the outgoing MOP, who should send the MTDs within 2 working days following receipt of the D0170.
3. The outgoing MOP will be required to send a D0268 for all Advanced meters when notified via the D0170 that a Migration is occurring.

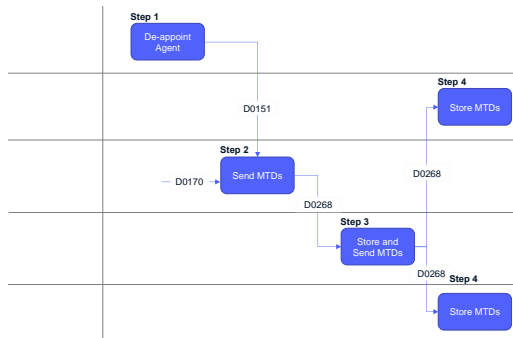

Process Diagram 23: Advanced (HH) Metering CoS – Transfer of MTDs

7.2.3 Transfer of Reads

1. Following the receipt of the D0170 from the Registration Service by the outgoing DC, as mentioned above, the outgoing DC will send a D0036 to the Incoming DS which contains 3 months of historical

HH profile data for the meter. This will then be used by the new DS to operate the MPAN under the new MHHS arrangements.

- The outgoing DC will also share HH data with the outgoing Supplier and LDSO via a D0036, as shown in Step 1005 in BPM-003 – Change of Service – Data Service – Forward Migration. Alternatively, a D0275 can be sent instead as per the legacy process optionality (note: the D0036 must always be sent between DC and DS).

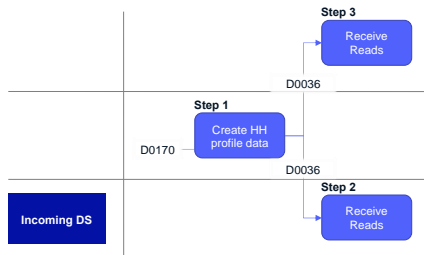

Process Diagram 24: Advanced (HH) Metering CoS – Transfer of Reads

7.3 Advanced Metering (NHH)

Under this scenario a MHHS Qualified Supplier chooses to migrate a MPAN that has an Advanced meter installed from Legacy NHH settlements to MHHS arrangements, coincident with a Switch that they have initiated.

7.3.1 Initiation and Acceptance of Appointment

The same processes as set out in section 7.1.2 of this document (for Traditional Metering) will be followed for Advanced Meters which are currently settled NHH.

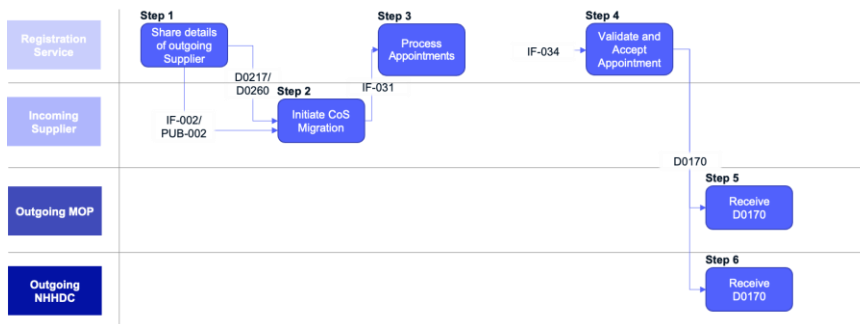

Process Diagram 25: Advanced (NHH) Metering CoS – Initiation and Acceptance of Appointment

7.3.2 Transfer of MTDs

- The process continues on BPM-002-Change of Service – Metering Service – Forward Migration, the outgoing Supplier to issue a D0151 to the old MOP (by the Supply Start Date); this message will

inform the MOP that they are to be de-appointed from servicing the MPAN and the data item 'Termination Reason' (J0279) should contain the value 'LC' as per Legacy arrangements.

2. The existing SLAs set out within the REC Metering Services Schedule associated to NHH MOPs will continue to be applicable to the outgoing MOP, who should send the D0268 within 5 working days following receipt of the D0170.
3. The outgoing MOP will be required to send a D0268 for all Advanced meters when notified via the D0170 that a Migration is occurring. The MOP will convert the current MTDs (which they will hold in a NHH D0150/D0149 and D0313) into a D0268 prior to sending to the new Metering Service.
4. NHH Advanced meters must also, when necessary, be reprogrammed by the MOP to support MHHS processes; or alternately be replaced if reprogramming not possible.

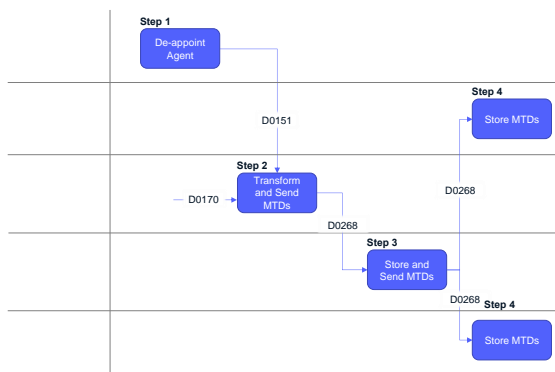

Process Diagram 26: Advanced (NHH) Metering CoS – Transfer of MTDs

7.3.3 Transfer of Reads

For an Advanced meter which is currently settled NHH there is no requirement for the NHHDC to share any reading data with the incoming DS. The rationale for this is that the new DS will not be able to make use of a D0010, as their processes require HH profile data not register readings.

1. Following receipt of a D0170 from the Registration Service, the NHHDC will obtain a remote reading from the Advanced meter, they will then validate the read or generate a deemed read (if a reading cannot be obtained) for the date of their effective to date, following the deeming rules (as currently set out in BSCP504), operating a process which replicates current BSCP504 Change of Measurement Class rules.
2. The outgoing DC will then send a D0086 / a D0019 to the outgoing Supplier (and a D0086 to the LDSO), who in turn will validate this read, this reading will close out the Legacy arrangements for settlements and customer billing.
3. In parallel the incoming DS will communicate with the Advanced meter and begin to collect HH profile data from their effective from date following the BAU MHHS Processes (note: BPM003c will not be followed as no historical data will be available via the DIP) related to data processing.

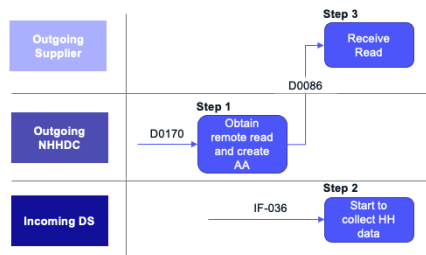

Process Diagram 27: Advanced (NHH) Metering CoS – Transfer of Reads

7.4 Smart Metering (NHH)

Under this scenario a MHHS Qualified Supplier chooses to migrate a MPAN that has a smart meter installed, from NHH settlements to MHHS arrangements, coincident with a Switch that they have initiated.

7.4.1 Initiation and Acceptance of Appointment

The same processes as set out in section 7.1.2 of this document (for Traditional Metering) will be followed for Smart Meters which are currently settled NHH.

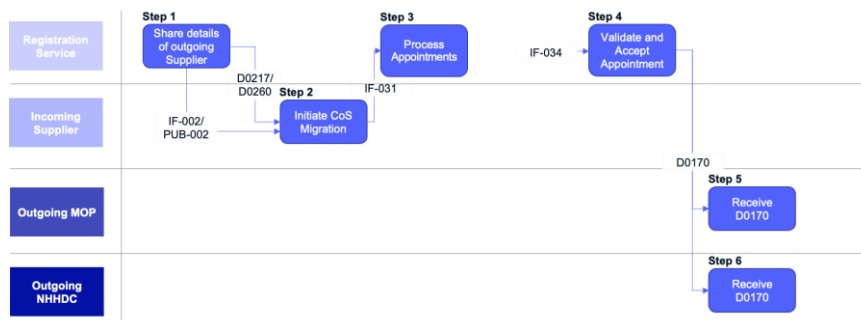

Process Diagram 28: Smart (NHH) Metering CoS – Initiation and Acceptance of Appointment

7.4.2 Transfer of MTDs

1. The process continues on BPM-002-Change of Service – Metering Service – Forward Migration, the outgoing Supplier to issue a D0151 to the old MOP (by the Supply Start Date); this message will inform the MOP that they are to be de-appointed from servicing the MPAN and the data item 'Termination Reason' (J0279) should contain the value 'LC' as per Legacy arrangements.
2. As this is a Smart meter, the outgoing MOP will not be required to follow any additional steps following the receipt of this D0170. Instead, the relevant MTDs will be shared with the new Metering Service by the Registration Service via the BAU MHHS CoA (MS) process, where they receive them via an IF-036 which is sent via the DIP to the new MS.

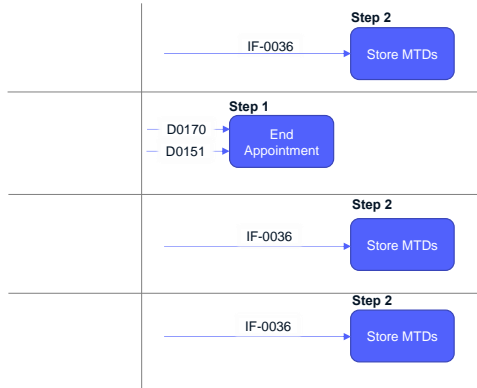

Process Diagram 29: Smart (NHH) Metering CoS – Transfer of MTDs

7.4.3 Transfer of Reads

1. Following Step 260 in BPM-003 – Change of Service – Data Service – Forward Migration, the incoming Data Service will retrieve a Midnight read from the Daily Read Log in the Smart meter and share this with the incoming Supplier, via an IF-041 to the DIP, which in turn is sent by the DIP to the incoming Supplier in a PUB-041, as per the BAU MHHS Design.
2. The IF-041 should contain the cumulative Read and each of the 48 TOU Registers.
3. The incoming Supplier will then validate this read and send it via a D0010 to the outgoing Supplier.
4. The D0010 should contain the cumulative read and each of the 48 TOU Registers (as per the current BSCP504 requirement).
5. The generated D0010 will be populated by the incoming Supplier with the following values:
 - a. ~~Reading Type (J0171) = VInitial~~
- b. ~~Meter Reading Reason Code = 29~~ (Forward Migration CoS)
6. The outgoing Supplier will then validate this read and compare to their own reading and share with the outgoing NHHDC via a D0010.
7. The generated D0010 will be populated by the outgoing Supplier with the following values:
 - a. ~~Reading Type (J0171) = VFinal~~
- b. ~~Meter Reading Reason Code = 29~~ (Forward Migration CoS)
8. The reading will contain the relevant TOU registers to align with the SSC.
9. Following the receipt of the D0170 by the outgoing DC, as mentioned above, and the receipt of the D0010, the outgoing DC will validate the read and create an AA with an Effective Date To Date of the Effective To Date of their appointment. They will then share this read with the outgoing Supplier via a D0086/D0019 and the outgoing Supplier will use this to close out billing. A D0086 will also be sent to the LDSO.
10. If the outgoing Supplier believes that the readings provided by the incoming Supplier are incorrect, they should initiate the D0300 process to resolve the CoS reading.

Commented [R(9)]: DIN-985

Formatted: No bullets or numbering

Commented [R(10)]: DIN-985

Formatted: No bullets or numbering

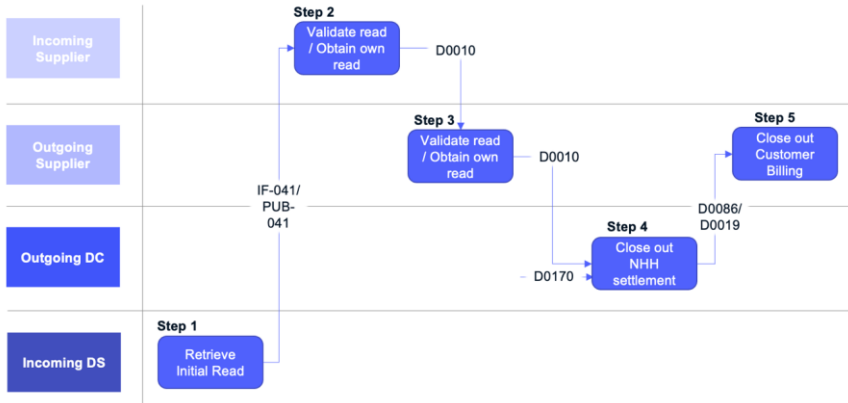

Process Diagram 30: Smart (NHH) Metering CoS – Transfer of Reads

7.5 Smart Metering (Elective HH)

Under this scenario a MHHS Qualified Supplier chooses to migrate a MPAN that has a smart meter installed, from HH settlements to MHHS arrangements, coincident with a Switch that they have initiated.

7.5.1 Initiation and Acceptance of Appointment

The same process as set out in section 7.1.1 for Traditional metering shall be followed.

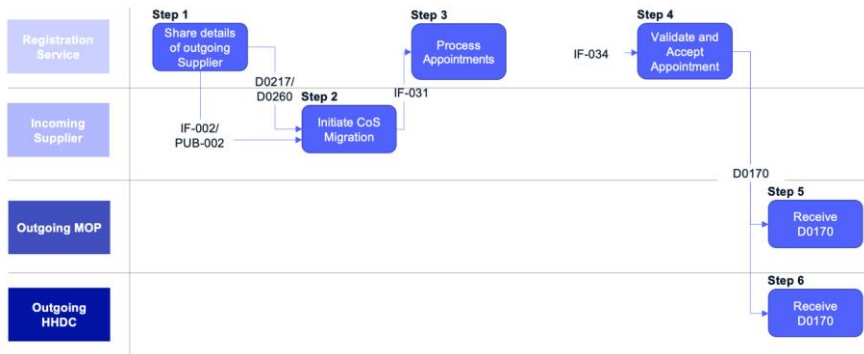

Process Diagram 31: Smart (Elective HH) Metering CoS – Initiation and Acceptance of Appointment

7.5.2 Transfer of MTDs

The same process as set out in section 7.4.2 for Smart Metering NHH shall be followed.

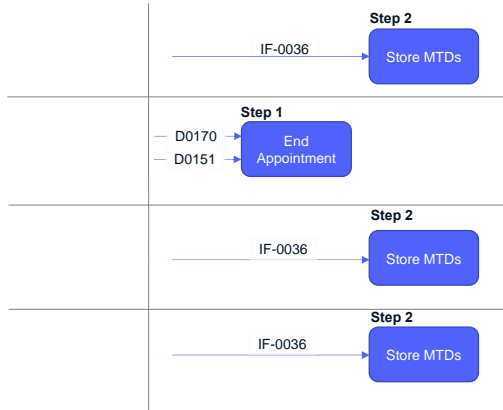

Process Diagram 32: Smart (Elective HH) Metering CoS – Transfer of MTDs

7.5.3 Transfer of Reads

1. There is no requirement for reads to be shared between the HHDC and the new DS within the Migration process for Smart Meters settled HH.
2. The HHDC will collect data for the day of their appointment, but they will follow the standard BSCP502 process for sharing data with other parties. The HHDC will be required to ensure that there is no data shared with the new DS if the Smart Meter is settled half-hourly.

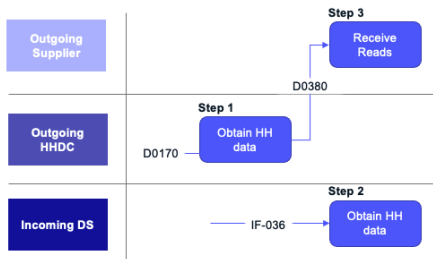

Process Diagram 33: Smart (HH) Metering CoS – Transfer of Reads

7.6 Unmetered MPANs

Under this scenario a Supplier chooses to migrate an Unmetered MPAN from Legacy HH settlements to MHHS arrangements, coincident with a Switch that they have initiated.

7.6.1 Initiation and Acceptance of Appointment

The process for Unmetered sites will follow the same process as that for the CoS Migration of other Market Segments with the exception that a D0170 will not be issued to the outgoing MA.

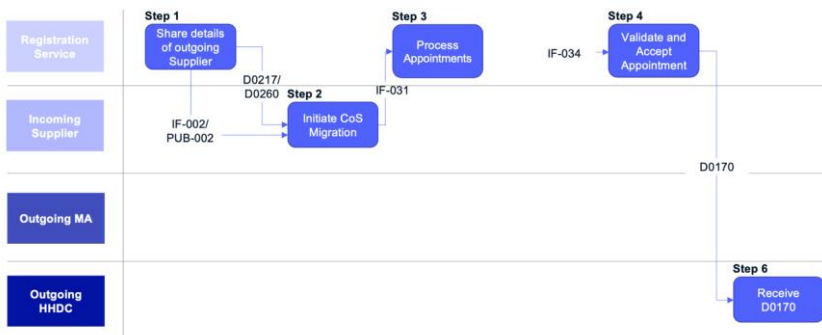

Process Diagram 34: Unmetered MPAN CoS – Initiation and Acceptance of Appointment

7.6.2 Transfer of Inventory Data

1. Once the outgoing MA has received D0151 (which will contain the termination reason 'LC', they stop operations on their Effective To Date.
2. The incoming MS (UMSO) will share inventory data, via the D0388, with the new DS (UMDS).

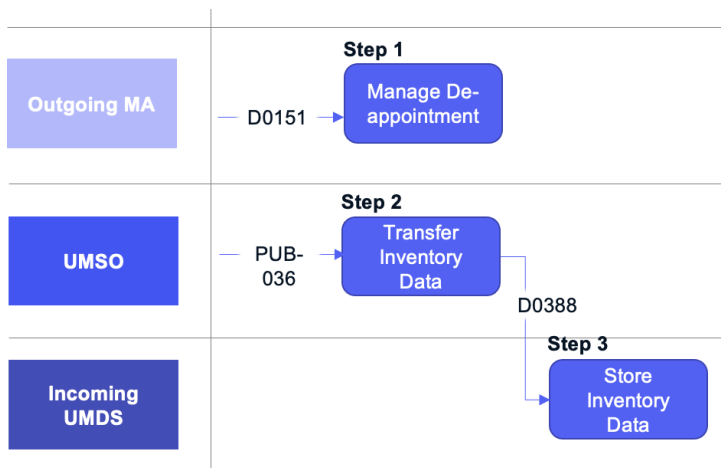

Process Diagram 35: Unmetered MPAN CoS – Transfer of Inventory Data

7.6.3 Transfer of Readings

For an Unmetered MPAN there is no requirement for the HHDC to share historical HH profile data with the incoming DS.

1. Following the receipt of the D0170 from the Registration Service by the outgoing DC, the outgoing DC will cease operations on their Effective To Date following the legacy process for data collection.

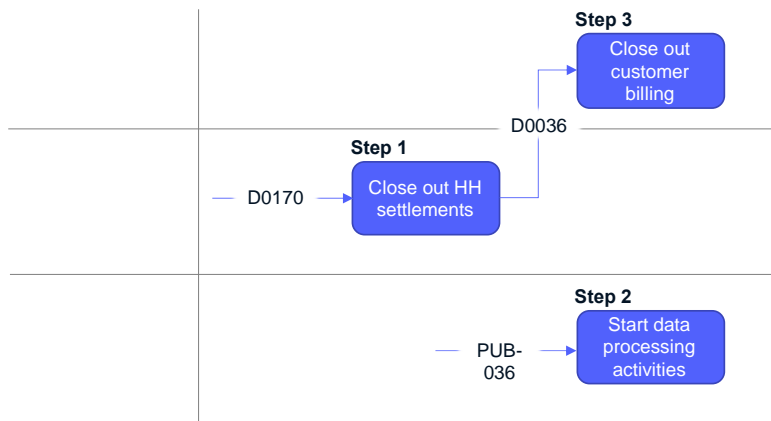

Process Diagram 36: Unmetered MPAN CoS – Transfer of Read Data

8 Reverse Migration – CoS

1. Reverse Migration refers to the process by which MPANs will go from being settled under the new MHHS arrangements to being settled under the Legacy arrangements when the incoming Supplier is not MHHS qualified.
2. The process has been designed to allow customers to switch between Suppliers throughout the Migration period irrespective of the Suppliers' qualification status. This means that if a customer's MPAN is being settled under the new MHHS arrangements, they can switch to a Supplier that has not yet qualified for MHHS.
3. This is the only use case for Reverse Migration; the process has not been designed for Suppliers to swap the arrangements under which MPANs within their customer base are settled or for customers to choose whether they are settled under the new arrangements or the Legacy arrangements.

As a result, unlike with Forward Migration, the Reverse Migration process can only be followed in the case of a Change of Supply and not a Change of Agent. However, given that the process of changing Agents is key to the Change of Supply process, the change of Agent process diagrams have been used to show how the Reverse Migration process should work.

8.1 Traditional Metering

Under this scenario a Legacy Supplier (one that has not become MHHS Qualified between M11 and M14), initiates a Switch for a consumer whose MPAN that has a Traditional meter installed, is operated under the MHHS arrangements.

8.1.1 Initiation and Acceptance of Appointment

1. Upon receipt of a Pending Registration Synchronisation from the CSS, the Registration Service will validate the status of the MPAN and the status of the Supplier associated to the Pending Registration.

2. If the MPAN has a status of being within the MHHS arrangements and the Supplier is not referenced as being MHHS Qualified within the Industry Standing Data, the Registration Service will initiate the Reverse Migration process.
3. The Registration Service will send the new Supplier the registration details of the outgoing Supplier and will confirm the Registration of the Meter point via a D0217 / D0260. As the incoming Supplier will be operating under the Legacy arrangements, the Registration Service will not send the site information to the new Supplier via an IF-002.
4. The Registration Service will create the Legacy data, required to populate the D0217 / D0260 data flows following the rules set out below:
 - a. If the MPAN existed previously in Legacy arrangements: The data associated to the last Legacy Supplier Registration will be populated (e.g., MOP/DC/DA appointments and settlement parameters such as Measurement Class, Profile Class, Standard Settlement Configuration etc.
 - b. The data to be populated will always default to the last Legacy Supplier registration, even if the last registration was MHHS and multiple MHHS switches have taken place since the MPAN was last registered to a Legacy Supplier.
 - c. If the MPAN did not previously exist in Legacy arrangements (i.e., a new connection under the MHHS arrangements): The Registration Service will create default values of:
 - i. A default MPID of 'MHHS' will be created for the DC, MOP, DA appointments.
 - ii. A default value for Measurement Class "F", Meter Timeswitch "800" will be created.
 - iii. This initial data population will ensure that existing processing and business rules will be utilised and the MPAN processed without exception. Reporting will be undertaken throughout the M11-M14 period (where Reverse Migrations can occur) to ensure that Suppliers correctly replace the default values with actual data mitigating risk to settlements.

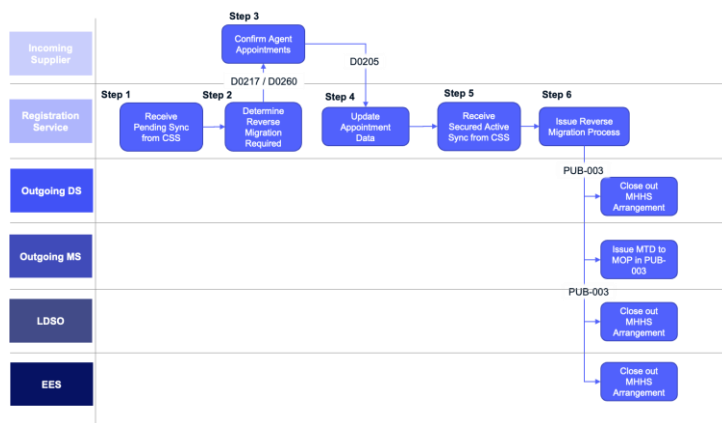

Process Diagram 37: Traditional Metering Reverse Migration – Initiation and Acceptance of Appointment

8.1.2 Transfer of MTDs

1. When the incoming Supplier is following the Reverse Migration process, the first step they will follow will be to send a D0155 to the incoming Legacy Agents. In this instance, they will send this D0155 to

the incoming MOP, who will in turn send a D0011 back to the incoming Supplier, accepting the appointment. The D0155 will be the definitive statement that a Reverse Migration process must be operated in place of the Legacy process when received by a Meter Operator, Data Collector or Meter Administrator.

2. It is proposed an additional Group 318 (Agreed Service Details) will be included. Within this group, the value of J0274 (Service Reference) will be 'REVM' and the value of the Service Level Reference J0275 will be 'REVM'. Applying this convention will give all participants a common means of identifying that the appointment is related to a Reverse Migration event.
3. It is essential the incoming MOP receives notification within the D0155 so that they are aware that the standard Legacy processes will not be followed, which in the case of Traditional metering means the MTDs will be sent from the outgoing Metering Service.
4. Once they receive this D0011, the incoming Supplier will then update the Agent appointment and settlement details and send a D0205 to the Registration Service.
5. This D0205 will contain the correct Agent appointments and settlement parameters under which they will be intending to operate the MPAN. It is essential the D0205 is sent prior to Secured Active status, which as a minimum must contain the identity of the new MOP, so the transfer of MTD process occurs successfully via the IF-003 (as detailed below).
6. The Registration Service will validate the D0205 appointments as they are processed. The D0205's are not queued so they cannot be re-validated (unlike Service Appointments). Normal D0205 processing will take place with the only change being that response flow (D0203) and CSS00200 will be issued throughout the day. The D0203 will be sent as per Legacy processes.
7. Multiple D0205's can be processed within this period, however MPRS will only use the information from the last accepted D0205 before Secured Active processing at 1800 hours to generate an IF-003 at Secured Active. Only one IF-003 will be generated, no IF-003's will be issued post-Secured Active meaning D0205's received after Secured Active will not generate an additional IF-003.
8. At this point, for confirmed appointments, they will then issue the MS de-appointment notification to the outgoing MS via an IF-003. This IF-003 will be sent to the DIP, who will then share it with the EES and the outgoing Supplier as well as the outgoing Metering Service.

However, if the D0205 is not sent to the Registration Service before the IF-003 is issued, the data fields used to confirm the identity of the DC and MOP will be blank; no default values will be populated. In this case, the Supplier will need to request their MOP manually provides the details of the incoming MOP and DC to the outgoing MS. Where a MOP receives this request, they should send a request to the outgoing MS within a defined time-period (2 working days). Where the outgoing MS receives this request, they must send the MTDs to the incoming MOP and DC within a defined period (5 working days) of receiving a valid request.

9. Once the outgoing Metering Service has received the IF-003, they will then follow the BAU process SLAs for sharing MTDs with the incoming MOP whereby a D0149/D0150 is sent to the incoming MOP who processes the MTDs and shares them with the incoming Supplier via a D0149/D0150 and with the incoming DC via a D0149/D0150 (using the legacy SLA of 5 working days).

Commented [ZH11]: DIN-762

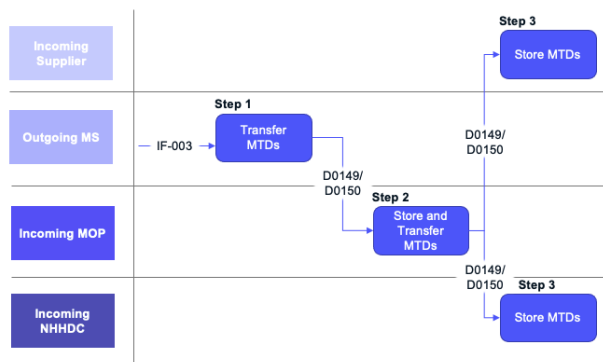

Process Diagram 38: Traditional Metering Reverse Migration – Transfer of MTDs

8.1.3 Transfer of Reads

1. When the incoming Supplier is following the Reverse Migration process, the first step they will follow will be to send a D0155 to the incoming Legacy Agents. The D0155 will be the definitive statement that a Reverse Migration process must be operated in place of the Legacy process when received by a Meter Operator, Data Collector or Meter Administrator.
2. It is proposed an additional Group 318 (Agreed Service Details) will be included. Within this group, the value of J0274 (Service Reference) will be 'REVM' and the value of the Service Level Reference J0275 will be 'REVM'. Applying this convention will give all participants a common means of identifying that the appointment is related to a Reverse Migration event.
3. It is essential that the incoming NHHDC receives notification, within the D0155, so that they are aware that the standard Legacy processes will not be followed, which in the case of Traditional metering means there is no outgoing NHHDC. No read history or CoS readings will be exchanged between NHHDC's, and the process set out in the following steps will be followed.
4. In this instance, they will send this D0155 to the incoming DC, who will in turn send a D0011 back to the incoming Supplier, accepting the appointment. Once they receive this D0011, the incoming Supplier will then update the Agent appointment and settlement details and send a D0205 to the Registration Service.
5. The Registration Service will validate the D0205 appointments as they are processed. The D0205's are not queued so they cannot be re-validated (unlike Service Appointments). Normal D0205 processing will take place with the only change being that response flows D0203 and CSS00200 will be issued throughout the day. The D0203 will be sent as per Legacy processes.
6. Multiple D0205s can be processed, however MPRS will only use the information from the last accepted D0205 before Secured Active processing at 1800 hours to generate an IF-003 at Secured Active. Only one IF-003 will be generated, no IF-003's will be issued post-Secured Active and D0205's received after Secured Active will not generate an IF-003.
7. At the same time as sending the D0205, the incoming Supplier will also send a D0052 to the incoming DC as per the legacy process.
8. At this point, for confirmed appointments they will then issue the DS de-appointment notification to the outgoing DS via an IF-003. This IF-003 will be sent to the DIP, who will then share it with the EES, the LDSO, and the outgoing Supplier as well as the outgoing Data Service.
9. As mentioned above, when the incoming MOP has received the MTDs, they will then share them with the incoming DC via a D0149/D0150, who in turn will manage any discrepancies if required.

10. In parallel to this process, the incoming Supplier will also attempt to obtain a CoS read via a COR. They will then share this read (if obtained) with the outgoing Supplier via a D0010.

11. The generated D0010 will be populated by the incoming Supplier with the following values:

a. ~~Reading Type (J0171) = YInitial~~

Commented [R12]: DIN-985

b. ~~Meter Reading Reason Code = 30~~ (Reverse Migration CoS)

Formatted: No bullets or numbering

12. The outgoing Supplier will then validate the read and re-share it with the incoming Supplier (with the ~~Meter Reading Flag set to T or F~~) via a D0010. Or, in the case that no COR read was received from the incoming Supplier, the outgoing Supplier will create a CoS read and share a D0010 with the outgoing DS and the incoming Supplier (within 5 days of the CoS).

Commented [R13]: DIN-985

13. The generated D0010 will be populated by the outgoing Supplier with the following values:

a. ~~Reading Type (J0171) = YFinal~~

Commented [R14]: DIN-985

b. ~~Meter Reading Reason Code = 30~~ (Reverse Migration CoS)

Formatted: No bullets or numbering

14. The outgoing DS will utilise this reading to close out Settlement arrangements for their Effective To Date.

15. Once the incoming Supplier receives the D0010 from the outgoing Supplier, they will then share it with the new DC via a D0010, who will use this as a start read for NHH Legacy settlements.

16. The generated D0010 will be populated by the incoming Supplier with the following values:

a. ~~Reading Type (J0171) = YInitial~~

Commented [R15]: DIN-985

b. ~~Meter Reading Reason Code = 30~~ (Reverse Migration CoS)

Formatted: No bullets or numbering

17. Having been notified that the CoS event is related to a Reverse Migration (via the D0155) the NHHDC will operate a different process to the normal legacy process and shall know that the reading received from the Supplier (for the date of the CoS) is to be utilised to create the initial D0086/D0019 (and that there are no interactions with outgoing Agents).

18. The LDSO will also receive an Initial reading from NHHDC at this point via the D0086.

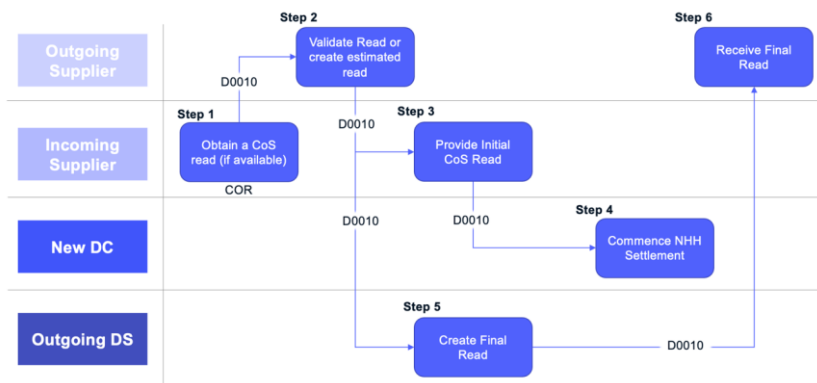

Process Diagram 39: Traditional Metering Reverse Migration – Transfer of Reads

8.2 Advanced Metering

Under this scenario a Legacy Supplier (one that has not become MHHS Qualified between M11 and M14), initiates a Switch for a consumer whose MPAN has an Advanced meter installed and is operated under the MHHS arrangements.

8.2.1 Initiation and Acceptance of Appointment

The same process set out in section 8.1.1 will be followed for Advanced metering when a Reverse Migration occurs.

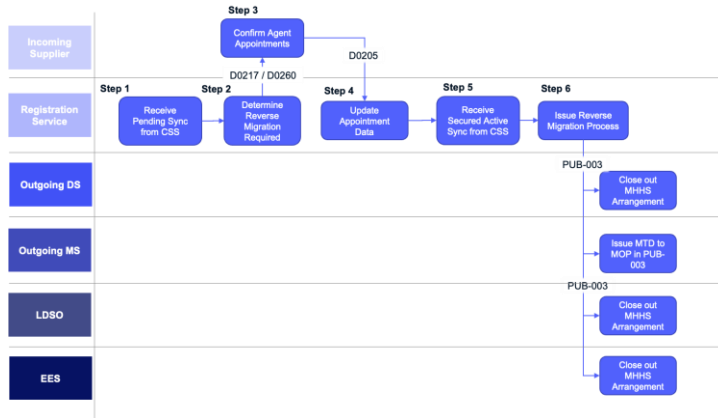

Process Diagram 37: Advanced Metering Reverse Migration – Initiation and Acceptance of Appointment

8.2.2 Transfer of MTDs

1. When the incoming Supplier is following the Reverse Migration process, the first step they will follow will be to send a D0155 to the incoming Legacy Agents. In this instance, they will send this D0155 to the incoming MOP, who will in turn send a D0011 back to the incoming Supplier, accepting the appointment. The D0155 will be the definitive statement that a Reverse Migration process must be operated in place of the Legacy process when received by a Meter Operator, Data Collector or Meter Administrator.
2. It is proposed an additional Group 318 (Agreed Service Details) will be included. Within this group, the value of J0274 (Service Reference) will be 'REVM' and the value of the Service Level Reference J0275 will be 'REVM'. Applying this convention will give all participants a common means of identifying that the appointment is related to a Reverse Migration event.
3. It is essential that the incoming MOP receives notification within the D0155 so that they are aware that the standard Legacy processes will not be followed, which in the case of Advanced metering means the MTDs will be sent from the outgoing Metering Service.
4. Once they receive this D0011, the incoming Supplier will then update the Agent appointment and settlement details and send a D0205 to the Registration Service.
5. The Supplier will then be required to send a D0205, prior to the Switch becoming Secured Active, which will contain the correct Agent appointments and settlement parameters under which they will be intending to operate the MPAN.
6. It is essential that the D0205 is sent prior to Secured Active status, which as a minimum must contain the identity of the new MOP, so that the transfer of MTDs process occurs successfully via the IF-003 (as detailed below). However, if the D0205 is not sent to the Registration Service before the IF-003 is issued, the data fields used to confirm the identity of the DC and MOP will be blank; no default values will be populated. In this case, the Supplier will need to request that their MOP

manually provides the details of the incoming MOP and DC to the outgoing MS. Where a MOP receives this request, they should send a request to the outgoing MS within a defined time-period (2 working days). Where the outgoing MS receives this request, they must send the MTDs to the incoming MOP and DC within a defined period (5 working days) of receiving a valid request.

7. The Registration Service will validate the D0205 appointments as they are processed. The D0205's are not queued so they cannot be re-validated (unlike Service Appointments). Normal D0205 processing will take place with the only change being that response flows D0172, D0203 and CSS00200 will be issued throughout the day. The D0203 will be sent as per Legacy processes.
8. Multiple D0205s can be processed, however MPRS will only use the information from the last accepted D0205 before Secured Active processing at 1800 hours to generate an IF-003 at Secured Active. Only one IF-003 will be generated, no IF-003's will be issued post-Secured Active and D0205's received after Secured Active will not generate an IF-003.
9. At this point, for confirmed appointments they will then issue the MS de-appointment notification to the outgoing MS via an IF-003. This IF-003 will be sent to the DIP, who will then share it with the EES and the outgoing Supplier as well as the outgoing Metering Service.
10. The IF-003 will contain the identities of the DC and MOP if they were provided in the D0205. If this data was not provided as part of the D0205 or only one of their identities was confirmed in the D0205, this data would not be present or only that line would be included.
11. Once the outgoing Metering Service has received the IF-003, they will then follow the BAU process for sharing MTDs with the incoming MOP whereby a D0268 and a (D0383/D0384 if available) is sent to the incoming MOP who processes the MTDs and shares them with the incoming Supplier via a D0268 and with the incoming DC via a D0268.
12. If the Supplier has determined that they wish to settle the MPAN NHH coincident with a Change of Supplier they will be required to instruct the MOP to transform the MTDs from a D0268 to a D0150/D0149 and a D0313 via the appointment processes and D0142, which will contain a reference to the Standard Settlement Configuration that the meter should be capable of supporting.

Commented [ZH16]: DIN-762

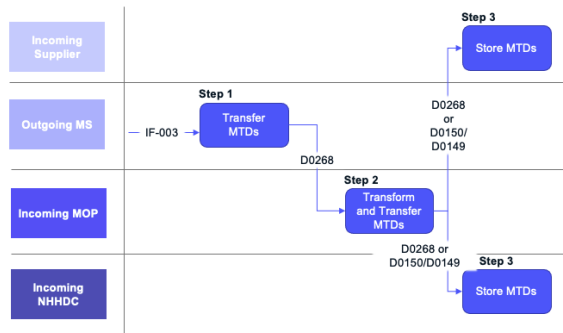

Process Diagram 38: Advanced Metering Reverse Migration – Transfer of MTDs

8.2.3 Transfer of Reads

1. When the incoming Supplier is following the Reverse Migration process, the first step they will follow will be to send a D0155 to the incoming Legacy Agents. The D0155 will be the definitive statement that a Reverse Migration process must be operated in place of the Legacy process when received by a Meter Operator, Data Collector or Meter Administrator.

2. The Supplier may choose to revert the Advanced meter to NHH settlements coincident with the Reverse Migration CoS. In which case a NHHDC will be appointed, and a MOP instructed to support a NHH configuration.
3. It is proposed an additional Group 318 (Agreed Service Details) will be included. Within this group, the value of J0274 (Service Reference) will be 'REVM' and the value of the Service Level Reference J0275 will be 'REVM'. Applying this convention will give all participants a common means of identifying that the appointment is related to a Reverse Migration event.
4. It is essential that the incoming DC receives notification, within the D0155, so that they are aware that the standard Legacy processes will not be followed, which in the case of Advanced metering means there is no outgoing NHHDC or HHDC. No read history or CoS readings will be exchanged between DC's and the process set out in the following steps will be followed.
5. In this instance, they will send this D0155 to the incoming DC, who in turn will send a D0011 back to the incoming Supplier, accepting the appointment. Once they receive this D0011, the incoming Supplier will then update the Agent appointment and settlement details and send a D0205 to the Registration Service.
6. The Registration Service will validate the D0205 appointments as they are processed. The D0205's are not queued so they cannot be re-validated (unlike Service Appointments). Normal D0205 processing will take place with the only change being that response flows D0172, D0203 and CSS00200 will be issued throughout the day. The D0203 will be sent as per Legacy processes.
7. Multiple D0205s can be processed, however MPRS will only use the information from the last accepted D0205 before Secured Active processing at 1800 hours to generate an IF-003 at Secured Active. Only one IF-003 will be generated, no IF-003's will be issued post-Secured Active and D0205's received after Secured Active will not generate an IF-003.
8. At this point, for confirmed appointments they will then issue the DS de-appointment notification to the outgoing DS via an IF-003. This IF-003 will be sent to the DIP, who will then share it with the EES, the LDSO, and the outgoing Supplier as well as the outgoing Data Service.
9. As mentioned above, when the incoming MOP has received the MTDs, they will then share them with the incoming DC via a D0149/D0150 or D0268 (depending on the Legacy settlement arrangements they were requested to support), who in turn will manage any discrepancies if required.
10. For NHH settled Advanced meters:
 - a. At the same time as sending the D0205, the incoming Supplier will also send a D0052 to the incoming DC as per the legacy process.
 - b. The NHHDC will also retrieve the reading via remote communications. The reading (contained within a D0010) should be obtained on the day that their appointment becomes effective. This reading will be denoted as 'Initial' and sent to Supplier and LDSO along with a D0019 to the Supplier. The D0019 will contain a forward EAC. The EAC will be calculated based on the profile class as no historical data will be available.
 - c. A deemed reading should be created for the date of the CoS.
 - d. In parallel the outgoing DS will obtain HH profile data to the end of their appointment period following the MHHS BAU process.
 - e. No readings or historical HH profile data are shared between the outgoing DS and the incoming NHHDC when a Reverse Migration occurs in this scenario.
11. For HH settled Advanced meters:
 - a. The HHDC will begin collection of HH profile data from the start of their appointment period.
 - b. In parallel the outgoing DS will obtain HH profile data to the end of their appointment period following the MHHS BAU process.

- c. No readings or historical HH profile data are shared between the outgoing DS and the incoming HHDC when a Reverse Migration occurs in this scenario.

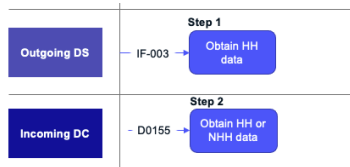

Process Diagram 39: Advanced Metering Reverse Migration – Transfer of Reads

8.3 Smart Metering

Under this scenario a Legacy Supplier (one that has not become MHHS Qualified between M11 and M14), initiates a Switch for a consumer whose MPAN has a smart meter installed and is operated under the MHHS arrangements.

8.3.1 Initiation and Acceptance of Appointment

The same process set out in section 8.1.1 will be followed for smart metering when a Reverse Migration occurs.

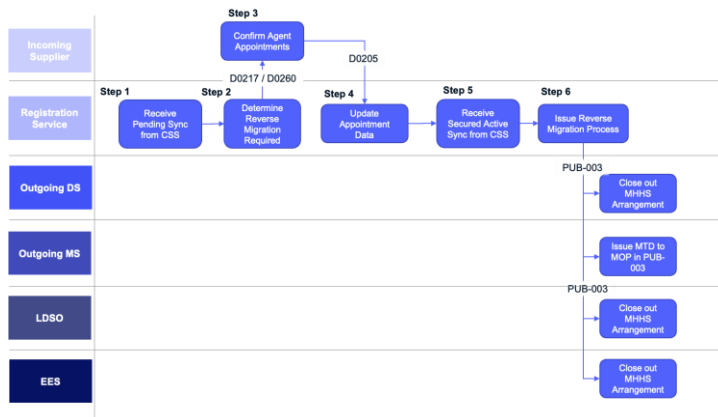

Process Diagram 40: Smart Metering Reverse Migration – Initiation and Acceptance of Appointment

8.3.2 Transfer of MTDs

1. When the incoming Supplier is following the Reverse Migration process, the first step they will follow will be to send a D0155 to the incoming Legacy Agents. In this instance, they will send this D0155 to the incoming MOP, who will in turn send a D0011 back to the incoming Supplier, accepting the appointment. The D0155 will be the definitive statement that a Reverse Migration process must be operated in place of the Legacy process when received by a Meter Operator, Data Collector or Meter Administrator.

2. It is proposed an additional Group 318 (Agreed Service Details) will be included. Within this group, the value of J0274 (Service Reference) will be 'REVM' and the value of the Service Level Reference J0275 will be 'REVM'. Applying this convention will give all participants a common means of identifying that the appointment is related to a Reverse Migration event.
3. It is essential that the incoming MOP receives notification within the D0155 so that they are aware that the standard Legacy processes will not be followed, which in the case of Smart metering means the MTDs will be sent from the outgoing Metering Service.
4. Once they receive this D0011, the incoming Supplier will then update the Agent appointment and settlement details and send a D0205 to the Registration Service.
5. The Supplier will then be required to send a D0205, prior to the Switch becoming Secured Active, which will contain the correct Agent appointments and settlement parameters under which they will be intending to operate the MPAN.
6. It is essential the D0205 is sent prior to Secured Active status, which as a minimum must contain the identity of the new MOP, so that the transfer of MTDs process occurs successfully via the IF-003 (as detailed below). However, if the D0205 is not sent to the Registration Service before the IF-003 is issued, the data fields used to confirm the identity of the DC and MOP will be blank; no default values will be populated. In this case, the Supplier will need to request that their MOP manually provides the details of the incoming MOP and DC to the outgoing MS. Where a MOP receives this request, they should send a request to the outgoing MS within a defined time-period (2 working days). Where the outgoing MS receives this request, they must send the MTDs to the incoming MOP and DC within a defined period (5 working days) of receiving a valid request.
7. The Registration Service will validate the D0205 appointments as they are processed. The D0205's are not queued so they cannot be re-validated (unlike Service Appointments). Normal D0205 processing will take place with the only change being that response flows D0172, D0203 and CSS00200 will be issued throughout the day. The D0203 will be sent as per Legacy processes.
8. Multiple D0205s can be processed, however MPRS will only use the information from the last accepted D0205 before Secured Active processing at 1800 hours to generate an IF-003 at Secured Active. Only one IF-003 will be generated, no IF-003's will be issued post-Secured Active and D0205's received after Secured Active will not generate an IF-003.
9. At this point, for confirmed appointments they will then issue the MS de-appointment notification to the outgoing MS via an IF-003. This IF-003 will be sent to the DIP, who will then share it with the EES and the outgoing Supplier as well as the outgoing Metering Service.
10. The IF-003 will contain the identities of the DC and MOP if they were provided in the D0205.
11. Once the outgoing Metering Service has received the IF-003, they will then create a 'Skeleton D0150' which will represent the smart meter related to the MPAN.
12. The D0150 will then be sent by the Metering Service to the incoming MOP and the incoming Supplier.
13. Following receipt of the D0150 the Supplier will send a D0367 which shall contain the tariff configuration that they have applied to the smart meter.
14. Following receipt of the D0150 and D0367, the MOP will create a valid D0150/D0149 pair and send to the NHHDC and Supplier to enable the operation of NHH Legacy settlement processes.

Commented [ZH17]: DIN-762

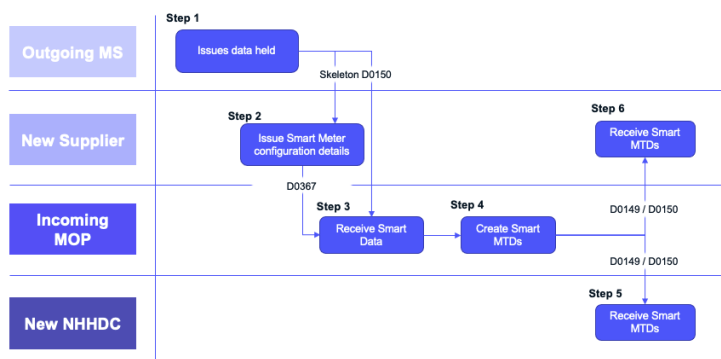

Process Diagram 41: Smart Metering Reverse Migration – Transfer of MTDs

8.3.3 Transfer of Reads

When the incoming Supplier is following the Reverse Migration process, the first step they will follow will be to send a D0155 to the incoming Legacy Agents. The D0155 will be the definitive statement that a Reverse Migration process must be operated in place of the Legacy process when received by a Meter Operator, Data Collector or Meter Administrator.

2. It is proposed an additional Group 318 (Agreed Service Details) will be included. Within this group, the value of J0274 (Service Reference) will be 'REVM' and the value of the Service Level Reference J0275 will be 'REVM'. Applying this convention will give all participants a common means of identifying that the appointment is related to a Reverse Migration event.
3. It is essential that the incoming DC receives notification within the D0155, so that they are aware that the standard Legacy processes will not be followed, which in the case of smart metering means there is no outgoing NHHDC. No read history or CoS readings will be exchanged between DCs, and the process set out in the following steps will be followed.
4. In this instance, they will send this D0155 to the incoming DC, who will in turn send a D0011 back to the incoming Supplier, accepting the appointment. Once they receive this D0011, the incoming Supplier will then update the Agent appointment and settlement details and send a D0205 to the Registration Service.
5. The Registration Service will validate the D0205 appointments as they are processed. The D0205's are not queued so they cannot be re-validated (unlike Service Appointments). Normal D0205 processing will take place with the only change being that response flows D0172, D0203 and CSS00200 will be issued throughout the day. The D0203 will be sent as per Legacy processes.
6. Multiple D0205s can be processed, however MPRS will only use the information from the last accepted D0205 before Secured Active processing at 1800 hours to generate an IF-003 at Secured Active. Only one IF-003 will be generated, no IF-003's will be issued post-Secured Active and D0205's received after Secured Active will not generate an IF-003.
7. At the same time as sending the D0205, the incoming Supplier will also send a D0052 to the incoming NHHDC as per the legacy process.
8. At this point, for confirmed appointments they will then issue the DS de-appointment notification to the outgoing DS via an IF-003. This IF-003 will be sent to the DIP, who will then share it with the EES, the LDSO, and the outgoing Supplier as well as the outgoing Data Service.

9. As mentioned above, when the incoming MOP has received and created the smart MTDs, they will then share them with the incoming DC via a D0149/D0150, who in turn will manage any discrepancies if required.
10. In parallel to this process, the outgoing DS will attempt to gather smart reads from the Daily read Log within the smart meter, before issuing a read to the outgoing Supplier via an IF-041. This IF-041 will be sent to the DIP, who in turn will share it with the outgoing Supplier and the LDSO via a PUB-041.
11. The IF-041 will contain the cumulative meter read and the 48 TOU register reads within the meter.
12. The outgoing Supplier will then compare and validate these actual readings before issuing a read to the new Supplier via a D0010. If the meter has no operable comms, the Supplier should estimate a reading.
13. The generated D0010 will be populated by the outgoing Supplier with the following values:
 - a. Reading Type (J0171) = YFinal
 - b. Meter Reading Reason Code = 30 (Reverse Migration CoS)
14. The D0010 should contain the cumulative meter read and the 48 TOU register reads within the meter.
15. Once the incoming Supplier receives this D0010, they will compare this reading to one they have remotely retrieved and then share it with the incoming DC via a D0010.
16. The generated D0010 will be populated by the incoming Supplier with the following values:
 - a. Reading Type (J0171) = YInitial
 - b. Meter Reading Reason Code = 30 (Reverse Migration CoS)
17. The D0010 should contain the TOU registers associated to the SSC which they have instructed the NHHDC to operate.
18. Where the incoming Supplier believes that a reading received from the outgoing Supplier is incorrect, they should initiate the D0300 process to resolve.

Commented [R(18)]: DIN-985
Formatted: No bullets or numbering

Commented [R(19)]: DIN-985
Formatted: No bullets or numbering



Process Diagram 42: Smart Metering Reverse Migration – Transfer of Reads

8.4 Unmetered Sites

Under this scenario a Legacy Supplier (one that has not become MHHS Qualified between M11 and M14), initiates a Switch for a consumer whose MPAN is an Unmetered Site and is operated under the MHHS arrangements.

8.4.1 Initiation and Acceptance of Appointment

The same process set out in section 8.1.1 will be followed for smart metering when a Reverse Migration occurs.

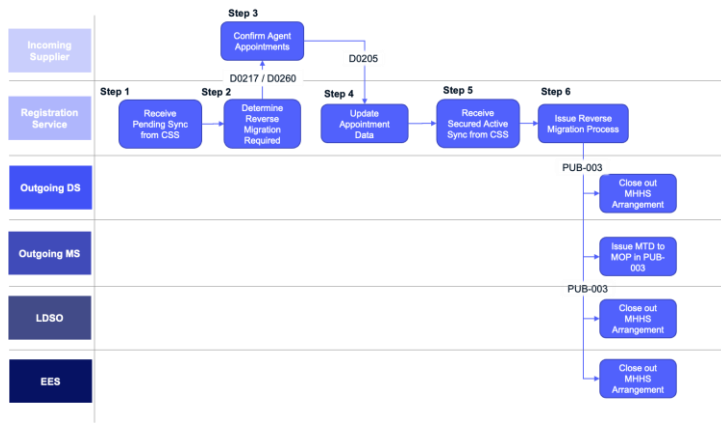

Process Diagram 43: Unmetered Sites Reverse Migration – Initiation and Acceptance of Appointment

8.4.2 Transfer of Inventory Data

1. The incoming Supplier will appoint the MA via a D0155 or via other agreed means.
2. The UMISO will provide inventory data to the MA via the D0388 data flow.

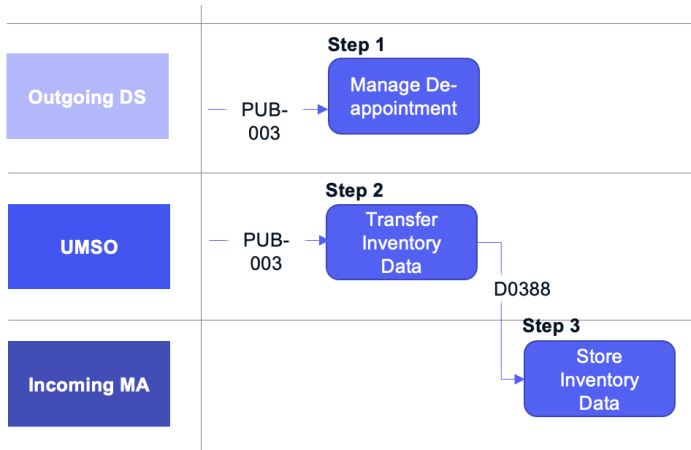

Process Diagram 44: Unmetered Sites Reverse Migration – Transfer of Inventory Data

8.4.3 Transfer of Reads

There will be no transfer of reads for Unmetered Sites.

The new HHDC will be notified that a Reverse Migration is occurring via the D0155 and will commence HH legacy operations, with the knowledge that no outgoing HHDC counterparty exists.

9 Related MPANs

1. Related MPANs will be treated in line with the business rules set out as part of the MHHS BAU Design throughout the Migration period.
2. An IF-031 can only ever be submitted to migrate a Primary MPAN. Any IF-031 that is submitted for a Secondary MPAN will be rejected.
3. Secondary MPANs will automatically be migrated alongside Primary MPANs. Following the appointment of the Service Provider, the Registration Service will send an IF-036 for both Primary and Secondary MPANs.
4. Separate D0170's will be issued for all Primary and Secondary MPANs.
5. The same MS and DS must be appointed to Primary and Secondary MPANs.
6. For Reverse Migration, Primary and Secondary MPANs will undergo a Switch and Migration at the same point in time. A Pending Registration must be received for each MPAN separately and the Registration Service will not perform any auto-Reverse Migration.

10 Import / Export MPANs

1. Unlike Related MPANs, the rules that apply to the treatment of Import / Export MPANs as part of Migration will differ to the rules set out as part of the MHHS BAU Design. There will be Migration-specific business rules and requirements and the BAU business rules will not become effective until both Import / Export MPANs have been migrated.
2. Separate IF-031s must be submitted for both the Import and Export MPANs pre-Migration. The Export MPAN will not be automatically migrated following successful Migration of the Import MPAN. So even though DNOs will link Import / Export MPANs pre-Migration, the Import and Export MPANs will migrate independently of one another.
3. The Agents of Import / Export MPANs can differ pre-Migration, but post-Migration (when both the Import and Export pair have been migrated) the Import and Export MPANs must be appointed to the same MS and DS. Note, the metering service will be auto-aligned for all Market Segments. However, the data service will only be aligned in the case of the Advanced Data Service (ADS), and not in the case of the Smart Data Service (SDS).
4. In order to make the above happen, the Registration Service will perform a daily scan for any Import / Export MPANs where both Import and Export MPANs have been fully migrated, but they have been appointed to different Agents. Where any examples of this occur, the Registration Service will auto-align the Export MPAN to the Import MPAN by sending an IF-036. This is the same functionality that is contained within the BAU Design, the only difference being that for Migration both Import and Export MPANs need to have been fully migrated for auto-alignment to occur.
5. In the case of Reverse Migration, Import and Export MPANs will reverse migrate independently of one another. If one of the Import / Export pairing undergoes a Reverse Migration as it undergoes a CoS from a MHHS Qualified Supplier to an Unqualified Supplier, this does not mandate the other Import / Export MPAN in the pairing to also undergo a Reverse Migration (unless it simultaneously undergoes a CoS from a MHHS Qualified Supplier to an Unqualified Supplier).
6. If an Import / Export pairing undergo Forward or Reverse Migration separately and so one of the pairing has a MOP appointed whilst the other has a MS appointed at the same point in time, the MOP and MS must belong to the same organisation.

11 Exception Handling

11.1.1 Missing MTDs

If for whatever reason the incoming MS (for Forward Migration) or MOP (for Reverse Migration) fails to receive the expected MTDs they should undertake an exception process to resolve.

1. EES or (for the MS only) the IF-036 should be checked to validate that meters are installed on the MPAN.
2. If meters are recorded in either the EES or Registration Service, the MS/MOP should contact their counterparty and request that the MTDs are correctly sent.

11.1.2 Missing Readings / Deemed Reads

1. It is essential the same readings are used to open and close settlement arrangements for Smart and Traditional Meters so as to avoid settlement or customer billing issues.
2. The processes have been developed to ensure that in those scenarios, readings are shared between Suppliers to ensure the same reading is utilised.
3. Where a COR is not obtained by the incoming Supplier, the NHHDC is required to deem a reading.
4. If no valid actual Meter register reading is received by the NHHDC in the SSD-5 and SSD+5 window, the NHHDC shall calculate a deemed Forward Migration or concurrent change of Supplier and Change of Forward Migration reading.
5. Where it has been identified by the NHHDC that there has been a Forward Migration and the NHHDC has not received a valid actual Meter register reading by SSD+5, the NHHDC shall deem a reading for the date of the concurrent change of Supplier and Forward Migration using the last valid read taken for the NHH Metering System and a Deemed Meter Advance calculated using the Last Valid EAC over the Deemed Meter Advance Period starting on the date of the last valid read and ending on the day before the date of the Forward Migration or concurrent change of Supplier and Forward Migration.
6. The NHHDC shall provide the deemed concurrent change of Supplier and Forward Migration reading to its Supplier.
7. The NHHDC shall determine the AA from the last valid reading to the date of the concurrent change of Supplier and Forward Migration reading in accordance with 3.3.11 of BSCP 504 and shall provide this with corresponding Effective From Settlement Date and Effective To Settlement Date to the NHHDA.
8. In the case of Reverse Migration for Traditional Meters, it is essential the outgoing Supplier creates a reading for the date of the CoS and provides this to the incoming Supplier. The incoming NHHDC will not have any other means to create an Initial read (as no history is transferred).
9. Incoming Suppliers will be required to contact outgoing Suppliers if this read is not sent.

11.1.3 Cancelled Appointments on Reverse Migration

If a Reverse Migration is cancelled (as the Switch is cancelled) then Suppliers will need to notify the Agent that the appointment as set out in the D0155 will not occur.

Suppliers can either send a D0151 with an effective date to date D-1 of the effective to date in the D0155 or use some other convention or communication means.

If this is not actioned exceptions will be created between the DC and DA when future processing occurs.

11.1.4 Correcting Legacy Data within the Registration Service

When a Forward or Reverse Migration has occurred the Registration Service will no longer accept messages generated under the previous arrangements. Historical corrections to data MPAN data will need to be corrected by a service management request to the LDSO.

In the case of MTDs, the MOP or MS should notify the incoming MOP or MS of changes who in turn will update meter data in the Registration Service using the appropriate DIP or DTN message.

11.1.5 Correcting Incorrect Forward Migration CoA Readings

It is the Suppliers responsibility to ensure that the correct reading is used for final and initial readings within the NHHDC and DS. If the reading used for the Migration event is incorrect, they should send corrected reads to the NHHDC and DS following the Migration process.

12 Non- Functional Requirements / Constraints

Non-functional requirements, such as volume constraints, will be addressed within the Migration Working Group and be set out within the Transition Approach.

This functional Design is predicated on unconstrained volumes. Analysis undertaken within the Design activities has not identified any functional impacts to the Design that could occur based on the future definition of non-functional requirements.

13 Required Interface Changes to Support Migration Design

As referenced within the prior description of the detailed Design, there will be a number of changes required to Legacy data flows (as set out within the Energy Market Architecture Repository) and the MHHS Core Design Interface Catalogue (MHHS-DES138-Interface Catalogue v5.0).

This section provides a concise view of the changes required. These changes, following approval of the Migration Design, will be progressed alongside the wider legal text changes required for MHHS or changes will be made to the baselined Programme Design Artefacts via the Programme change process.

There are several messages, both D flows and DIP messages, that are included as part of the following section, but are not referenced elsewhere in the Migration Design. These messages have been included here to make clear the rejection rules and rejection codes that should be applied to them once a MPAN enters either the MHHS or Legacy arrangements. The messages that fall under this category are: D0304, D0312, D0386, IF-005, IF-006, IF-025, IF-026, IF-038, and IF-039 and IF-040.

Once a Forward Migration is initiated (indicated through the send of an IF-031) or if a MPAN is MHHS, the Registration Service will not accept Legacy D flows for a given MPAN. This will remain the case until a Reverse Migration occurs.

Once a Reverse Migration is initiated (indicated through the receipt of a Pending Registration) or if a MPAN is Legacy, the Registration Service will not accept DIP flows for a given MPAN. This will remain the case until a Forward Migration occurs.

13.1 Legacy Data Flow Changes

13.1.1 D0170

1. The structure of the D0170 will not change.
2. Data Item 'Requested Action Code' (J0007) related enumeration will include 2 additional values:
 - a. Enumeration Value: 24; Enumeration Description: Migration CoA
 - b. Enumeration Value: 25; Enumeration Description: Migration CoS
3. New Scenario Variants:

Commented [RS20]: DIN-1021

- a. Registration Service to Meter Operator (including Meter Administrator)
 - b. Registration Service to Data Collector
 - c. The use of enumeration value 24 and 25 should only be permissible for those two scenario variants of the D0170.
4. Business Rules:
- a. Will be the definitive statement that a Migration process must be operated in place of the Legacy process when received by a Meter Operator, Data Collector or Meter Administrator.
 - b. The receiving parties (MEM/DC) should treat the incoming MOP field as incoming MS and incoming DC field as incoming DS. This is so they can properly target the DTN flows where required. If this is not done, there is a risk of sending incorrect role codes which could lead to file failures.
-

13.1.2 D0155

- 1. The structure of the D0155 will not change.
 - 2. New Data Item Rule: If the Agent appointment is coincident with a Reverse Migration an additional Group 318 (Agreed Service Details) will be included. Within this group, the below values will be included:
 - a. Service Reference (J0274) will be 'REVM'
 - b. Service Level Reference (J0275) will be 'REVM'
 - 3. Business Rules:
 - a. Will be the definitive statement that a Reverse Migration process must be operated in place of the Legacy process when a D0155 with the values specified above is received by a Meter Operator, Data Collector or Meter Administrator.
-

13.1.3 D0010

- 1. The structure of the D0010 will not change.
 - 2. Data Item 'Reading Type' (J0171) related enumeration will include 3 additional values:
 - a. Enumeration Value: U; Enumeration Description: Forward Migration CoA
 - b. Enumeration Value: V; Enumeration Description: Forward Migration CoS
 - c. Enumeration Value: Y; Enumeration Description: Reverse Migration
 - 3. Business Rules:
 - a. Will be the definitive statement that a Forward Migration or Reverse Migration process must be operated in place of the Legacy process when received by a Supplier.
 - b. Note: An outgoing Supplier will know from the D0010 received from the incoming Supplier, that a Switch is coincident with a Forward Migration so to operate a changed process; or a D0086 from a NHHDC when this value is utilised.
-

13.1.4 D0086

- 1. The structure of the D0086 will not change.
- 2. Data Item 'Reading Type' (J0171) related enumeration will include 3 additional values:

- a. Enumeration Value: U; Enumeration Description: Forward Migration CoA
 - b. Enumeration Value: V; Enumeration Description: Forward Migration CoS
 - c. Enumeration Value: Y; Enumeration Description: Reverse Migration
3. Business Rules:
- a. Will be the definitive statement that a Forward Migration or Reverse Migration process must be operated in place of the Legacy process when received by a Supplier.
 - b. Note: An outgoing Supplier will know from the D0010 received from the incoming Supplier that a Switch is coincident with a Forward Migration so to operate a changed process; or a D0086 from a NHHDC when this value is utilised.
 - c. Enumeration Value 28 will not be utilised within the D0086.

13.1.5 Skeleton D0150

- 1. The Skeleton D0150 has the same structure as a conventional D0150.
- 2. Business Rules:
 - a. The only difference between the Skeleton D0150 and a conventional D0150 is that the Skeleton D0150 only has the mandatory values populated. Any optional values are left blank.

13.1.6 D0203

- 1. The structure of the D0203 will not change.
- 2. Data Item 'Rejection Reason Code' (J0107) related enumeration will include 1 additional value:
 - a. Enumeration Value: 62; Enumeration Description: Forward Migration Underway or MPAN is MHHS
- 3. Business Rules:
 - a. If a Forward Migration is underway or MPAN is already MHHS and a D0205 is sent, this will be rejected. A D0203 will be sent back with enumeration value 62 in the 'Rejection Reason Code' data item to specify the rejection reason.

13.1.7 D0205

- 1. The structure of the D0205 will not change.
- 2. New validation rule will be applied to the D0205:
 - a. "Reject if Forward Migration underway or MPAN is MHHS"
- 3. Business Rules:
 - a. If a Forward Migration is underway or MPAN is already MHHS and a D0205 is sent, this will be rejected. A D0203 will be sent back with enumeration value 62 in the 'Rejection Reason Code' data item to specify the rejection reason.

13.1.8 D0304

- 1. The structure of the D0304 will not change.
- 2. New validation rule will be applied to the D0304:
 - a. "Reject if Forward Migration underway or MPAN is MHHS"

3. Data Item 'MPAS D0304 Response Code' (J2255) related enumeration will include 1 additional value:
 - a. Enumeration Value: Q; Enumeration Description: Forward Migration Underway or MPAN is MHHS
4. Business Rules:
 - a. If a Forward Migration is underway or MPAN is already MHHS and a D0304 is sent, this will be rejected. A D0304 will be sent back with enumeration value Q in the 'MPAS D0304 Response Code' data item to specify the rejection reason.

13.1.9 D0312

1. The structure of the D0312 will not change.
2. New validation rule will be applied to the D0312:
 - a. "Reject if Forward Migration underway or MPAN is MHHS"
3. Data Item 'MOP Flow Response Code' (J2256) related enumeration will include 1 additional value:
 - a. Enumeration Value: AD; Enumeration Description: Forward Migration Underway or MPAN is MHHS
4. Business Rules:
 - a. If a Forward Migration is underway or MPAN is already MHHS and a D0312 is sent, this will be rejected. A D0312 will be sent back with enumeration value AD in the 'MOP Flow Response Code' data item to specify the rejection reason.

13.1.10 D0386

1. The structure of the D0386 will not change.
2. New validation rule will be applied to the D0386:
 - a. "Reject if Forward Migration underway or MPAN is MHHS"
3. Data Item 'Related MPAN Response Code' (J2240) related enumeration will include 1 additional value:
 - a. Enumeration Value: Y; Enumeration Description: Forward Migration Underway or MPAN is MHHS
4. Business Rules:
 - a. If a Forward Migration is underway or MPAN is already MHHS and a D0386 is sent, this will be rejected. A D0386 will be sent back with enumeration value Y in the 'Related MPAN Response Code' data item to specify the rejection reason.

13.1.11 Legacy EES Extract

1. Forward Migration: Registration Service to remove MPAN from inclusion in the Legacy EES Extract upon successful completion of Forward Migration – this will be indicated through the send of an IF-036.
2. Reverse Migration: As soon as an IF-003 is sent, marking the completion of a Reverse Migration, Registration Service to add MPAN back into the Legacy EES Extract.

13.1.12 **D0148**

1. The structure of the D0148 will not change.
2. In regards to population of the D0148 for Reverse Migration, the D0148 should be populated in the same way as a New Connection, where only the new agents are required rather than any old.
 - a. The new connection process can be found in section 9 of Annex C.
3. The MOA should receive a D0148 containing:
 - a. The New DC Only
4. The DC should receive the D0148 containing:
 - a. The new MOA
 - b. The New DA

2.

13.2 MHHS Interface Specification Changes

13.2.1 IF-031

1. The structure of the IF-031 will not change.
2. Data Item 'Service Provider Appointment Scenario' (DI-980) related enumeration will include 2 additional values:
 - a. Enumeration Value: MCS; Enumeration Description: Migration CoS
 - b. Enumeration Value: MCA; Enumeration Description: Migration CoA
3. New validation rules will be applied to the IF-031:
 - a. REG1039 – Appointments barred on Related Secondary MPAN [DI-063], use Primary MPAN [Reg.LinkedPrimaryMPAN] (N.B. this validation rule is existing as part of MHHS Design)
 - b. ~~REG1094 – MPAN is Legacy and non-Migration appointment code is use REG9009 - MHHS Scenario Codes cannot be used for UnMigrated MPAN d~~
 - c. ~~REG1095 – Pending Registration – Migration Canceled REG9004 - Third Party Switch in Progress d~~
4. Business Rules:
 - a. If the IF-031 'Service Provider Appointment Scenario' equals "MCS" or "MCA", the MPAN is currently 'Legacy' and the MPAN is 'Import'; the IF-031 will be accepted, validation checks and automated appointment of Agents related to the Import MPAN will not occur.
 - b. If the IF-031 'Service Provider Appointment Scenario' equals "MCS" or "MCA", the MPAN is currently 'Legacy' and the MPAN is 'Export'; the IF-031 will be accepted, validation checks and automated appointment of Agents related to the Import MPAN will not occur.
 - i. Note: Import and Export MPANs will be migrated independently of one another as the need for Suppliers to collaborate (e.g., both must be MHHS Qualified) will introduce significant complexity to the Migration processes. The BAU business rules related to Import and Export will only be applicable once both the Import and Export MPAN of a given pair are migrated to the MHHS arrangements.
 - c. If a Pending Switch exists; and, the IF-031 'Service Provider Appointment Scenario' equals "MCS" or "MCA" and the MPAN is currently 'Legacy', the Registration Service will reject the Migration attempt and return the relevant error code.

Commented [RS21]: DIN-984

Formatted: Font: (Default) Arial, 11 pt, Font color: Auto, Border: : (No border)

Formatted: Font: (Default) Arial, 11 pt, Font color: Auto, Border: : (No border)

Formatted: Font: 11 pt, Border: : (No border)

Formatted: Font: 11 pt

Formatted: List Paragraph, Pattern: Clear (White)

Formatted: Numbered + Level: 2 + Numbering Style: a, b, c, ... + Start at: 1 + Alignment: Left + Aligned at: 1.9 cm + Indent at: 2.54 cm

Formatted: No bullets or numbering

Commented [ZH(22)]: DIN-1021

- d. The IF-031 'Service Provider Appointment Scenario' should read "MCA" when a Supplier's registration is Active.
 - e. The IF-031 'Service Provider Appointment Scenario' should read "MCS" when the current Supplier's registration is Pending.
 - f. Forward Migration should only be possible if the RMP status for an MPAN is either "Operational" or "Created". Reverse Migration should only be possible if the RMP status for an MPAN is "Operational". If the RMP status for an MPAN is any value other than the ones prescribed above, it should not be possible to initiate the relevant Migration.
 - g. If MPAN is a Secondary MPAN and an IF-031 is sent using a Migration appointment code in the 'Service Provider Appointment Scenario' data item i.e., "MCS" or "MCA", the IF-031 will be rejected using REG1039 validation rule. An IF-032 will then be sent back with Response Code (DI-979): R; and Response Message (DI-980): REG1039 - Appointments barred on Related Secondary MPAN [DI-063], use Primary MPAN [Reg.LinkPrimaryMPAN].
 - h. If MPAN is Legacy and an IF-031 is sent using a non-Migration appointment code in the 'Service Provider Appointment Scenario' data item i.e., not "MCS" or "MCA", the IF-031 will be rejected using REG1039 validation rule. An IF-032 will then be sent back with Response Code (DI-979): R; and Response Message (DI-980): REG9009 - MHHS Scenario Codes cannot be used for UnMigrated MPAN. If a Pending switch is already in place and a Migration is initiated, the IF-031 will be rejected using REG~~9004~~~~1095~~ validation rule. An IF-032 will then be sent back with Response Code (DI-979): R; and Response Message (DI-980): ~~REG1095 - Pending Registration - Migration Cancelled~~ ~~REG9004 - Third Party Switch in Progress~~.
5. Note: The value will also be present in all other related appointment messages (e.g., IF-032, 33, 34, 35, 36).

Commented [ZH23]: DIN-949

Commented [ZH(24)]: DIN-1021

13.2.2 IF-032

1. The structure of the IF-032 will not change.
2. Data Item 'Response Message' (DI-980) related enumeration will include 3 additional values:
 - a. Enumeration Value: 'REG1039 – Appointments barred on Related Secondary MPAN [DI-063], use Primary MPAN [Reg.LinkPrimaryMPAN]'
 - b. Enumeration Value: 'REG9009 – MHHS Scenario Codes cannot be used for UnMigrated MPAN. Enumeration Value: ~~REG1095 – Pending Registration - Migration Cancelled~~ ~~REG9004 - Third Party Switch in Progress~~'
3. Business Rules:
 - a. If MPAN is a Secondary MPAN and an IF-031 is sent using a Migration appointment code in the 'Service Provider Appointment Scenario' data item i.e., "MCS" or "MCA", the IF-031 will be rejected using REG1039 validation rule. An IF-032 will then be sent back with Response Code (DI-979): R; and Response Message (DI-980): REG1039 – Appointments barred on Related Secondary MPAN [DI-063], use Primary MPAN [Reg.LinkPrimaryMPAN].
 - b. If MPAN is Legacy and an IF-031 is sent using a non-Migration appointment code in the 'Service Provider Appointment Scenario' data item i.e., "MCS" or "MCA", the IF-031 will be rejected using REG9009 validation rule. An IF-032 will then be sent back with Response Code (DI-979): R; and Response Message (DI-980): REG9009 – MHHS Scenario Codes cannot be used for UnMigrated MPAN. If a Pending switch is already in place and a Migration is initiated, the IF-031 will be rejected using REG~~1095~~~~9004~~ validation rule. An IF-032 will then be sent back with Response Code (DI-979): R; and Response Message (DI-980): ~~REG1095 - Pending Registration - Migration Cancelled~~ ~~REG9004 - Third Party Switch in Progress~~.

Commented [ZH25]: DIN-949

Commented [ZH26]: DIN-949

Commented [ZH(27)]: DIN-1021

13.2.3 IF-035

4. The structure of the IF-035 will not change.

5. Business Rules:

- a. If a Pending Registration is received for an MPAN that has an in progress Forward Migration, when the D-1 effective from status of the Agent appointment is reached, the Registration Service will revert the MPAN back to Legacy status and send an IF-035 to Service Providers and Supplier informing them that the Forward Migration has been cancelled using Lapsed code LP006

Commented [ZH28]: DIN-946

13.2.4 IF-003

1. The structure of the IF-003 will be updated to include 'Incoming Supplier Details.'

2. The two new data items within the 'Incoming Supplier Details' will be:

- a. RevMig Incoming Supplier MPID
- b. RevMig Incoming Supplier Effective From Date

3. Business Rules:

- a. In the case of Smart Meters undergoing Reverse Migration only, the Registration Service will populate the 'Incoming Supplier Details' as part of the IF-003 which is sent to the outgoing MS (via the DIP). This is so the outgoing MS can correctly route the Skeleton D0150 to the new Supplier (which in turn enables the new Supplier to generate a D0367).
- b. If the D0205 is not sent to the Registration Service before the IF-003 is issued, the data fields used to confirm the identity of the DC and MOP will be blank; no default values will be populated. In this case, the DC and MOP will need to contact the Supplier to initiate a manual transfer of data.

13.2.5 IF-005

1. The structure of the IF-005 will not change.

2. New validation rule will be applied to the IF-005:

- a. ~~REG1029 — Reverse Migration is underway or MPAN is Legacy~~ REG9003 - MHHS MTD Updates cannot be used until Migration has completed y

3. Business Rules:

- a. If a Reverse Migration is underway or MPAN is Legacy and an IF-005 is sent, this will be rejected using ~~REG1029~~ REG9003 validation rule. An IF-006 will be sent back with Response Code (DI-979): R; and Response Message (DI-980): ~~REG1029 — Reverse Migration is underway or MPAN is Legacy~~ REG9003 - MHHS MTD Updates cannot be used until Migration has completed.

Commented [ZH(29)]: DIN-1021

13.2.6 IF-006

1. The structure of the IF-006 will not change.

2. Data Item 'Response Message' (DI-980) related enumeration will include 1 additional value:

- a. Enumeration Value: '~~REG1029 — Reverse Migration is underway or MPAN is Legacy~~ REG9003 - MHHS MTD Updates cannot be used until Migration has completed'

3. Business Rules:

- a. If a Reverse Migration is underway or MPAN is Legacy and an IF-005 is sent, this will be rejected using REG~~10299003~~ validation rule. An IF-006 will be sent back with Response Code (DI-979): R; and Response Message (DI-980): ~~REG1029—Reverse Migration is underway or MPAN is Legacy~~ REG9003 - MHHS MTD Updates cannot be used until Migration has completed.

Commented [ZH(30)]: DIN-1021

13.2.7 IF-019

1. The structure of the IF-019 will not change.
2. New validation rule will be applied to the IF-019:
 - a. ~~REG1066—Reverse Migration is underway or MPAN is Legacy~~
 - b. a. ~~REG1067—Forward Migration is underwa~~ REG9010 - Cannot Manage MPAN Relationships for an Unmigrated MPANy
3. Business Rules:
 - a. If a Reverse Migration is underway or MPAN is Legacy and an IF-019 is sent, this will be rejected using REG~~10669010~~ validation rule. An IF-020 will then be sent back with Response Code (DI-979): R; and Response Message (DI-980): ~~REG1066—Reverse Migration is underway or MPAN is Legacy~~ REG9010 - Cannot Manage MPAN Relationships for an Unmigrated MPAN.
 - b. If a Forward Migration is underway and an IF-019 is sent, this will be rejected using REG~~90101067~~ validation rule. An IF-020 will then be sent back with Response Code (DI-979): R; and Response Message (DI-980): ~~REG1067—Forward Migration is underway~~ REG9010 - Cannot Manage MPAN Relationships for an Unmigrated MPAN.

Formatted: Font: (Default) +Body (Arial)

Commented [ZH(31)]: DIN-1021

13.2.8 IF-020

1. The structure of the IF-020 will not change.
2. Data Item 'Response Message' (DI-980) related enumeration will include 12 additional values:
 - a. Enumeration Value: ~~REG1066—Reverse Migration is underway or MPAN is Legacy~~ REG9010 - Cannot Manage MPAN Relationships for an Unmigrated MPAN'
 - b. ~~Enumeration Value: 'REG1067—Forward Migration is underway'~~
3. Business Rules:
 - a. If a Reverse Migration is underway or MPAN is Legacy and an IF-019 is sent, this will be rejected using REG~~10669010~~ validation rule. An IF-020 will be sent back with Response Code (DI-979): R; and Response Message (DI-980): ~~REG1066—Reverse Migration is underway or MPAN is Legacy~~ REG9010 - Cannot Manage MPAN Relationships for an Unmigrated MPAN.
 - b. If a Forward Migration is underway and an IF-019 is sent, this will be rejected using REG~~10679010~~ validation rule. An IF-020 will then be sent back with Response Code (DI-979): R; and Response Message (DI-980): ~~REG1067—Forward Migration is underway~~ REG9010 - Cannot Manage MPAN Relationships for an Unmigrated MPAN.

Commented [ZH(32)]: DIN-1021

13.2.9 IF-025

1. The structure of the IF-025 will not change.
2. New validation rule will be applied to the IF-025:

- a. ~~REG1046 — Reverse Migration is underway or MPAN is Legacy~~ REG9002 - Supplier Data Items Cannot be Maintained for an Unmigrated MPAN y

Formatted: Font: (Default) +Body (Arial)

3. Business Rules:

- a. If a Reverse Migration is underway or MPAN is Legacy and an IF-025 is sent, this will be rejected using REG~~1046~~9002 validation rule. An IF-026 will be sent back with Response Code (DI-979): R; and Response Message (DI-980): ~~REG1046 — Reverse Migration is underway or MPAN is Legacy~~ REG9002 - Supplier Data Items Cannot be Maintained for an Unmigrated MPAN.

Commented [ZH(33)]: DIN-1021

13.2.10 IF-026

1. The structure of the IF-026 will not change.
2. Data Item 'Response Message' (DI-980) related enumeration will include 1 additional value:

- a. Enumeration Value: '~~REG1046 — Reverse Migration is underway or MPAN is Legacy~~ REG9002 - Supplier Data Items Cannot be Maintained for an Unmigrated MPAN'

3. Business Rules:

- a. If a Reverse Migration is underway or MPAN is Legacy and an IF-025 is sent, this will be rejected using REG~~1046~~9002 validation rule. An IF-026 will be sent back with Response Code (DI-979): R; and Response Message (DI-980): ~~REG1046 — Reverse Migration is underway or MPAN is Legacy~~ REG9002 - Supplier Data Items Cannot be Maintained for an Unmigrated MPAN.

Commented [ZH(34)]: DIN-1021

13.2.11 IF-038

1. The structure of the IF-038 will not change.
2. New validation rule will be applied to the IF-038:

- a. ~~REG1075 — Reverse Migration is underway or MPAN is Legacy~~ REG9001 - CDC Marker Cannot be applied to an Unmigrated MPAN y

Formatted: Font: (Default) +Body (Arial)

3. Business Rules:

- a. If a Reverse Migration is underway or MPAN is Legacy and an IF-038 is sent, this will be rejected using REG~~1075~~9001 validation rule. An IF-039 will be sent back with Response Code (DI-979): R; and Response Message (DI-980): ~~REG1075 — Reverse Migration is underway or MPAN is Legacy~~ REG9001 - CDC Marker Cannot be applied to an Unmigrated MPAN.

Commented [ZH(35)]: DIN-1021

13.2.12 IF-039

1. The structure of the IF-039 will not change.
2. Data Item 'Response Message' (DI-980) related enumeration will include 1 additional value:

- a. Enumeration Value: '~~REG1075 — Reverse Migration is underway or MPAN is Legacy~~ REG9001 - CDC Marker Cannot be applied to an Unmigrated MPAN'

3. Business Rules:

- a. If a Reverse Migration is underway or MPAN is Legacy and an IF-038 is sent, this will be rejected using REG~~1075~~9001 validation rule. An IF-039 will be sent back with Response Code (DI-979): R; and Response Message (DI-980): ~~REG1075 — Reverse Migration is~~

~~underway or MPAN is Legacy REG9001 - CDC Marker Cannot be applied to an Unmigrated MPAN.~~

Commented [ZH(36)]: DIN-1021

~~13.2.13 IF-040~~

Commented [RS37]: DIN-1021

- ~~1. The structure of the IF-040 will not change.~~
- ~~2. New Level 4 validation rule will be applied to the IF-040:
 - ~~a. RCP1076 – Reverse Migration is underway or MPAN is Legacy~~~~
- ~~3. Business Rules:
 - ~~a. If a Reverse Migration is underway or MPAN is Legacy and an IF-040 is sent, this will be rejected using RCP1076 validation rule. A DIP specific error API response will then be returned (asynchronous equivalent).~~~~

13.3 Industry Standing Data (ISD) Entity Design

1. The below details and table are taken from the 'Industry Standing Data: MHHS Entities/Data Items v5.0' document produced by the Core Design team. The section to refer to is ISD Entity Id M16 – Market Participant to DIP Participant Mapping.
2. Business Rules:
 - a. The Registration Service will need to refer to this information upon initiation of a Migration event to determine the Qualification status of a Supplier. The Registration Service will determine whether the Migration event to occur is either a Forward or Reverse Migration based on the provided Qualification information.
 - b. The presence of a DIP Participant ID and an Effective From Date in the ISD table will indicate a Supplier as Qualified from the Effective From Date. If either, or both, of these values are absent from the ISD table, the Supplier is not Qualified.
 - c. The Effective From Date will represent the date that the Supplier is both Qualified from and has declared themselves as being operational under MHHS from. The Supplier Effective From Date is not mirrored from MDD.

Column Name	Data Type/Length	Other information
Market Participant Id	4 characters	Mandatory
Market Participant Role Code ¹	1 character	Mandatory
DIP Participant Id	Up to 10 characters	Mandatory
DIP Role Code	4 character	Mandatory
Effective From Date {MM2DPM} ²	Date	Mandatory
Effective To Date {MM2DPM} ²	Date	Optional

¹ The valid set of values is contained in the ISD table Market Role (ISD Entity Id 21)

² The Effective From and To Dates refer to this Market Participant to DIP Participant Mapping table.

Example

Market Participant Id	Market Participant Role Code	DIP Participant	DIP Role Code	Effective From Date {MP2DPM}	Effective To Date {MP2DPM}
BGAS	X	0307871100	SUPP	2023-04-01	

14 Reporting

The following reporting requirements will be required from services to monitor and support the Migration processes:

Reporting Service	Report Name	Report Description	Recipients
DIP	Initiated Forward Migrations	A report which will record each IF-031 received for a Migration initiated by a Supplier MPID, by Market Segment and Data Service.	MHHS Programme, Elexon PAF
DIP	Completed Forward Migrations	A report which will record each IF-036 sent for a Migration initiated by a Supplier MPID, by Market Segment and Data Service.	MHHS Programme, Elexon PAF
DIP	Completed Reverse Migrations	A report which will record each IF-003 sent for a Migration initiated by a Supplier, by Market Segment and Data Service.	MHHS Programme, Elexon PAF
DTS	Incomplete Reverse Migrations	A report which will record where an MPANs related appointment and settlement data has not been updated from a default value via a D0205.	MHHS Programme, Elexon PAF
DTS	NHH Reading	A report to validate that the same readings are utilised to open and close arrangements	MHHS Programme, Elexon PAF

DIP	Incomplete Forward Migrations	A report that will validate each MPAN where an IF-031 was accepted but a subsequent IF-036 has not been sent on or after the effective from date.	MHHS Programme, Elexon PAF
-----	-------------------------------	---	----------------------------

15 Additional Artefacts / Appendix

Below is a list of the artefacts that have been produced as part of the Migration Design workstream:

- MHHS-DEL962 - BPM-001 - Change of Supply – Forward Migration
- MHHS-DEL963 - BPM-002 - Change of Service – Metering Service – Forward Migration
- MHHS-DEL964 - BPM-003 - Change of Service – Data Service – Forward Migration
- MHHS-DEL965 - BPM-001 - Change of Supply – Reverse Migration
- MHHS-DEL966 - BPM-002 - Change of Service – Metering Service – Reverse Migration
- MHHS-DEL967 - BPM-003 - Change of Service – Data Service – Reverse Migration
- MHHS-DEL968 - BPD001 - Change of Supply – Forward Migration
- MHHS-DEL969 - BPD002 - Change of Service – Metering Service – Forward Migration
- MHHS-DEL970 - BPD003 - Change of Service – Data Service – Forward Migration
- MHHS-DEL971 - BPD001 - Change of Supply – Reverse Migration
- MHHS-DEL972 - BPD002 - Change of Service – Metering Service – Reverse Migration
- MHHS-DEL973 - BPD003 - Change of Service – Data Service – Reverse Migration
- MHHS-DEL974 - Migration Design Requirements Log
- MHHS-DEL989 - IF-003 Interface Specification
- MHHS-DEL819 - Migration Design Subgroup Decisions, Actions and Comments Tracker